

**PHILIPPINE BIDDING DOCUMENTS**  
(As Harmonized with Development Partners)

**Procurement of  
INFRASTRUCTURE  
PROJECTS**

Government of the Republic of the Philippines

*Name of the Project : “1 Lot Supply, Delivery and Installation  
of Fiber Optic Network (Re-Bid)”*

*ITB No. :* 003.21

*Procuring Entity :* Philippine Heart Center  
East Avenue, Quezon

**Sixth Edition**  
**July 2020**

# Preface

These Philippine Bidding Documents (PBDs) for the procurement of Infrastructure Projects (hereinafter referred to also as the “Works”) through Competitive Bidding have been prepared by the Government of the Philippines for use by all branches, agencies, departments, bureaus, offices, or instrumentalities of the government, including government-owned and/or -controlled corporations, government financial institutions, state universities and colleges, local government units, and autonomous regional government. The procedures and practices presented in this document have been developed through broad experience, and are for mandatory use in projects that are financed in whole or in part by the Government of the Philippines or any foreign government/foreign or international financing institution in accordance with the provisions of the 2016 revised Implementing Rules and Regulations (IRR) of Republic Act (RA) No. 9184.

The PBDs are intended as a model for admeasurements (unit prices or unit rates in a bill of quantities) types of contract, which are the most common in Works contracting.

The Bidding Documents shall clearly and adequately define, among others: (i) the objectives, scope, and expected outputs and/or results of the proposed contract; (ii) the eligibility requirements of Bidders; (iii) the expected contract duration; and (iv) the obligations, duties, and/or functions of the winning Bidder.

Care should be taken to check the relevance of the provisions of the PBDs against the requirements of the specific Works to be procured. If duplication of a subject is inevitable in other sections of the document prepared by the Procuring Entity, care must be exercised to avoid contradictions between clauses dealing with the same matter.

Moreover, each section is prepared with notes intended only as information for the Procuring Entity or the person drafting the Bidding Documents. They shall not be included in the final documents. The following general directions should be observed when using the documents:

- a. All the documents listed in the Table of Contents are normally required for the procurement of Infrastructure Projects. However, they should be adapted as necessary to the circumstances of the particular Project.
- b. Specific details, such as the “*name of the Procuring Entity*” and “*address for bid submission*,” should be furnished in the Instructions to Bidders, Bid Data Sheet, and Special Conditions of Contract. The final documents should contain neither blank spaces nor options.
- c. This Preface and the footnotes or notes in italics included in the Invitation to Bid, BDS, General Conditions of Contract, Special Conditions of Contract, Specifications, Drawings, and Bill of Quantities are not part of the text of the final document, although they contain instructions that the Procuring Entity should strictly follow.
- d. The cover should be modified as required to identify the Bidding Documents as to the names of the Project, Contract, and Procuring Entity, in addition to date of issue.
- e. Modifications for specific Procurement Project details should be provided in the Special Conditions of Contract as amendments to the Conditions of Contract. For easy completion, whenever reference has to be made to specific clauses in the Bid Data Sheet or Special Conditions of Contract, these terms shall be printed in bold typeface on Sections I (Instructions to Bidders) and III (General Conditions of Contract), respectively.

- f. For guidelines on the use of Bidding Forms and the procurement of Foreign-Assisted Projects, these will be covered by a separate issuance of the Government Procurement Policy Board.

## TABLE OF CONTENTS

|  |           |
|--|-----------|
| <b>GLOSSARY OF .....</b>   | <b>6</b>  |
| <b>TERMS, ABBREVIATIONS, AND ACRONYMS.....</b>   | <b>6</b>  |
| <b>SECTION I. INVITATION TO BID.....</b>   | <b>8</b>  |
| <b>SECTION II. INSTRUCTIONS TO BIDDERS.....</b>  | <b>11</b> |
| <b>1.SCOPE OF BID.....</b>   | <b>12</b> |
| <b>2.FUNDING INFORMATION.....</b>  | <b>12</b> |
| <b>3.BIDDING REQUIREMENTS.....</b>   | <b>12</b> |
| <b>4.CORRUPT, FRAUDULENT, COLLUSIVE, COERCIVE, AND OBSTRUCTIVE<br/>PRACTICES.....</b>  | <b>12</b> |
| <b>5.ELIGIBLE BIDDERS .....</b>  | <b>12</b> |
| <b>6.ORIGIN OF ASSOCIATED GOODS .....</b>  | <b>13</b> |
| <b>7.SUBCONTRACTS.....</b>   | <b>13</b> |
| <b>8.PRE-BID CONFERENCE.....</b>   | <b>13</b> |
| <b>9.CLARIFICATION AND AMENDMENT OF BIDDING DOCUMENTS.....</b>                         | <b>13</b> |
| <b>10.DOCUMENTS COMPRISING THE BID: ELIGIBILITY AND TECHNICAL<br/>COMPONENTS .....</b> | <b>13</b> |
| <b>11.DOCUMENTS COMPRISING THE BID: FINANCIAL COMPONENT.....</b>                       | <b>14</b> |
| <b>12.ALTERNATIVE BIDS.....</b>  | <b>14</b> |
| <b>13.BID PRICES.....</b>  | <b>14</b> |
| <b>14.BID AND PAYMENT CURRENCIES.....</b>  | <b>14</b> |
| <b>15.BID SECURITY .....</b>   | <b>15</b> |
| <b>16.SEALING AND MARKING OF BIDS.....</b>   | <b>15</b> |
| <b>17.DEADLINE FOR SUBMISSION OF BIDS.....</b>   | <b>16</b> |
| <b>18.OPENING AND PRELIMINARY EXAMINATION OF BIDS .....</b>                            | <b>16</b> |
| <b>19.DETAILED EVALUATION AND COMPARISON OF BIDS .....</b>                             | <b>16</b> |
| <b>20.POST QUALIFICATION .....</b>   | <b>16</b> |
| <b>21.SIGNING OF THE CONTRACT.....</b>   | <b>17</b> |
| <b>SECTION III. BID DATA SHEET.....</b>  | <b>18</b> |
| <b>SECTION IV. GENERAL CONDITIONS OF CONTRACT.....</b>                                 | <b>20</b> |
| <b>1.SCOPE OF CONTRACT.....</b>  | <b>21</b> |
| <b>2.SECTIONAL COMPLETION OF WORKS.....</b>  | <b>21</b> |

|   |           |
|---|-----------|
| <b>3.POSSESSION OF SITE.....</b>                                      | <b>21</b> |
| <b>4.THE CONTRACTOR’S OBLIGATIONS.....</b>                            | <b>21</b> |
| <b>5.PERFORMANCE SECURITY.....</b>                                    | <b>21</b> |
| <b>6.SITE INVESTIGATION REPORTS.....</b>                              | <b>22</b> |
| <b>7.WARRANTY .....</b>   | <b>22</b> |
| <b>8.LIABILITY OF THE CONTRACTOR.....</b>                             | <b>22</b> |
| <b>9.TERMINATION FOR OTHER CAUSES.....</b>                            | <b>22</b> |
| <b>10.DAYWORKS.....</b>   | <b>22</b> |
| <b>11.PROGRAM OF WORK.....</b>  | <b>23</b> |
| <b>12.INSTRUCTIONS, INSPECTIONS AND AUDITS.....</b>                   | <b>23</b> |
| <b>13.ADVANCE PAYMENT.....</b>  | <b>23</b> |
| <b>14.PROGRESS PAYMENTS.....</b>                                      | <b>23</b> |
| <b>15.OPERATING AND MAINTENANCE MANUALS.....</b>                      | <b>23</b> |
| <b>SECTION V. SPECIAL CONDITIONS OF CONTRACT.....</b>                 | <b>24</b> |
| <b>SECTION VI. SPECIFICATIONS.....</b>                                | <b>30</b> |
| <b>SECTION VII. DRAWINGS.....</b>                                     | <b>32</b> |
| <b>SECTION VIII. BILL OF QUANTITIES.....</b>                          | <b>33</b> |
| <b>SECTION IX. CHECKLIST OF TECHNICAL AND FINANCIAL DOCUMENTS....</b> | <b>35</b> |
| <b>BID FORM.....</b>  | <b>42</b> |
| <b>SAMPLE FORM.....</b>   | <b>38</b> |
| <b>OMNIBUS SWORN STATEMENT (REVISED).....</b>                         | <b>38</b> |
| <b>BID SECURING DECLARATION.....</b>                                  | <b>41</b> |
| <b>BID FORM.....</b>  | <b>42</b> |

# *Glossary of Terms, Abbreviations, and Acronyms*

**ABC** – Approved Budget for the Contract.

**ARCC** – Allowable Range of Contract Cost.

**BAC** – Bids and Awards Committee.

**Bid** – A signed offer or proposal to undertake a contract submitted by a bidder in response to and in consonance with the requirements of the bidding documents. Also referred to as *Proposal* and *Tender*. (2016 revised IRR, Section 5[c])

**Bidder** – Refers to a contractor, manufacturer, supplier, distributor and/or consultant who submits a bid in response to the requirements of the Bidding Documents. (2016 revised IRR, Section 5[d])

**Bidding Documents** – The documents issued by the Procuring Entity as the bases for bids, furnishing all information necessary for a prospective bidder to prepare a bid for the Goods, Infrastructure Projects, and/or Consulting Services required by the Procuring Entity. (2016 revised IRR, Section 5[e])

**BIR** – Bureau of Internal Revenue.

**BSP** – Bangko Sentral ng Pilipinas.

**CDA** – Cooperative Development Authority.

**Consulting Services** – Refer to services for Infrastructure Projects and other types of projects or activities of the GOP requiring adequate external technical and professional expertise that are beyond the capability and/or capacity of the GOP to undertake such as, but not limited to: (i) advisory and review services; (ii) pre-investment or feasibility studies; (iii) design; (iv) construction supervision; (v) management and related services; and (vi) other technical services or special studies. (2016 revised IRR, Section 5[i])

**Contract** – Refers to the agreement entered into between the Procuring Entity and the Supplier or Manufacturer or Distributor or Service Provider for procurement of Goods and Services; Contractor for Procurement of Infrastructure Projects; or Consultant or Consulting Firm for Procurement of Consulting Services; as the case may be, as recorded in the Contract Form signed by the parties, including all attachments and appendices thereto and all documents incorporated by reference therein.

**Contractor** – is a natural or juridical entity whose proposal was accepted by the Procuring Entity and to whom the Contract to execute the Work was awarded. Contractor as used in these Bidding Documents may likewise refer to a supplier, distributor, manufacturer, or consultant.

**CPI** – Consumer Price Index.

**DOLE** – Department of Labor and Employment.

**DTI** – Department of Trade and Industry.

**Foreign-funded Procurement or Foreign-Assisted Project** – Refers to procurement whose funding source is from a foreign government, foreign or international financing institution as specified in the Treaty or International or Executive Agreement. (2016 revised IRR, Section 5[b]).

**GFI** – Government Financial Institution.

**GOCC** – Government-owned and/or –controlled corporation.

**Goods** – Refer to all items, supplies, materials and general support services, except Consulting Services and Infrastructure Projects, which may be needed in the transaction of

public businesses or in the pursuit of any government undertaking, project or activity, whether in the nature of equipment, furniture, stationery, materials for construction, or personal property of any kind, including non-personal or contractual services such as the repair and maintenance of equipment and furniture, as well as trucking, hauling, janitorial, security, and related or analogous services, as well as procurement of materials and supplies provided by the Procuring Entity for such services. The term “related” or “analogous services” shall include, but is not limited to, lease or purchase of office space, media advertisements, health maintenance services, and other services essential to the operation of the Procuring Entity. (2016 revised IRR, Section 5[r])

**GOP** – Government of the Philippines.

**Infrastructure Projects** – Include the construction, improvement, rehabilitation, demolition, repair, restoration or maintenance of roads and bridges, railways, airports, seaports, communication facilities, civil works components of information technology projects, irrigation, flood control and drainage, water supply, sanitation, sewerage and solid waste management systems, shore protection, energy/power and electrification facilities, national buildings, school buildings, hospital buildings, and other related construction projects of the government. Also referred to as *civil works or works*. (2016 revised IRR, Section 5[u])

**LGUs** – Local Government Units.

**NFCC** – Net Financial Contracting Capacity.

**NGA** – National Government Agency.

**PCAB** – Philippine Contractors Accreditation Board.

**PhilGEPS** - Philippine Government Electronic Procurement System.

**Procurement Project** – refers to a specific or identified procurement covering goods, infrastructure project or consulting services. A Procurement Project shall be described, detailed, and scheduled in the Project Procurement Management Plan prepared by the agency which shall be consolidated in the procuring entity's Annual Procurement Plan. (GPPB Circular No. 06-2019 dated 17 July 2019)

**PSA** – Philippine Statistics Authority.

**SEC** – Securities and Exchange Commission.

**SLCC** – Single Largest Completed Contract.

**UN** – United Nations.

## ***Section I. Invitation to Bid***

### **Notes on the Invitation to Bid**

The Invitation to Bid (IB) provides information that enables potential Bidders to decide whether to participate in the procurement at hand. The IB shall be posted in accordance with Section 21.2 of the 2016 revised IRR of RA No. 9184.

Apart from the essential items listed in the Bidding Documents, the IB should also indicate the following:

- a. The date of availability of the Bidding Documents, which shall be from the time the IB is first advertised/posted until the deadline for the submission and receipt of bids;
- b. The place where the Bidding Documents may be acquired or the website where it may be downloaded;
- c. The deadline for the submission and receipt of bids; and
- d. Any important bid evaluation criteria.

The IB should be incorporated into the Bidding Documents. The information contained in the IB must conform to the Bidding Documents and in particular to the relevant information in the Bid Data Sheet.



# *Philippine Heart Center*

## **Invitation to Bid for “1 Lot Supply, Delivery and Installation of Fiber Optic Network (Re-Bid)”**

1. The *Philippine Heart Center PHC*, through the *DOH HFEP Bayanihan 1 CY 2020* intends to apply the sum of ***Php4,000,000.00*** being the Approved Budget for the Contract (ABC) to payments under the contract for ***“1 Lot Supply, Delivery and Installation of Fiber Optic Network (Re-Bid)”***. Bids received in excess of the ABC shall be automatically rejected at bid opening.

### ***Select this for lot-procurement:***

The *Philippine Heart Center*, through the *DOH HFEP Bayanihan 1 CY 2020* intends to apply the sum of *Php4,000,000.00* being the Approved Budget for the Contract (ABC) to payments under the contract for each lot. Bids received in excess of the ABC for each lot shall be automatically rejected at bid opening.

2. The *Philippine Heart Center* now invites bids for the above Procurement Project. Completion of the Works is required *DOH HFEP Bayanihan 1 CY 2020*. Bidders should have completed a contract similar to the Project. The description of an eligible bidder is contained in the Bidding Documents, particularly, in Section II (Instructions to Bidders).
3. Bidding will be conducted through open competitive bidding procedures using non-discretionary “*pass/fail*” criterion as specified in the 2016 revised Implementing Rules and Regulations (IRR) of Republic Act (RA) No. 9184.
4. Interested bidders may obtain further information from *PHC Bids and Awards Committee (BAC)* and inspect the Bidding Documents at the address given below from *8:00 AM to 5:00 PM, Monday to Friday*.
5. A complete set of Bidding Documents may be acquired by interested bidders on *January 21, 2021* from given address and website/s below and upon payment of the applicable fee for the Bidding Documents, pursuant to the latest Guidelines issued by the GPPB, in the amount of *Five Thousand Pesos (Php5,000.00)*. The Procuring Entity shall allow the bidder to present its proof of payment for the fees in cash and *presented by the authorized person*.
6. The *Philippine Heart Center (PHC)* will hold a Pre-Bid Conference<sup>1</sup> on *Febrary 3, 2021, 11:00 AM* at *5<sup>th</sup> Flr. Amphitheater Conf. Rm. MAB Bldg., PHC* which shall be open to prospective bidders.

---

<sup>1</sup> May be deleted in case the ABC is less than One Million Pesos (PhP1,000,000) where the Procuring Entity may not hold a pre-bid conference.

7. Bids must be duly received by the BAC Secretariat through manual submission at the office address as indicated below, on *February 17, 2021, 11:00 AM*. Late bids shall not be accepted.

*PHC – Bids and Awards Committee  
5<sup>th</sup> Flr. Amphitheater Conference Room  
MAB Building., PHC*

8. All bids must be accompanied by a bid security in any of the acceptable forms and in the amount stated in **ITB** Clause 16.
9. Bid opening shall be on *February 17, 2021, 11:00 AM* at *5<sup>th</sup> flr. Amphitheater Conf. Rm. MAB Bldg., PHC*. Bids will be opened in the presence of the bidders' representatives who choose to attend the activity.
10. *[Insert such other necessary information deemed relevant by the Procuring Entity such as the use of a back-up data or cloud storage for large files uploaded for online bid submissions]*
11. The *Philippine Heart Center (PHC)* reserves the right to reject any and all bids, declare a failure of bidding, or not award the contract at any time prior to contract award in accordance with Sections 35.6 and 41 of the 2016 revised Implementing Rules and Regulations (IRR) of RA No. 9184, without thereby incurring any liability to the affected bidder or bidders.
12. For further information, please refer to:

***PHC – BAC Secretariat***  
*Bids and Awards Committee (BAC)*  
*Philippine Heart Center*  
*East Avenue, Quezon City*  
*Telefax No. : 925-2401 local 4059*  
*PHC Website : [www.phc.gov.ph](http://www.phc.gov.ph)*

13. You may visit the following websites:

For downloading of Bidding Documents: *[www.phc.gov.ph](http://www.phc.gov.ph)*

---

**RANULFO B. JAVELOSA, JR., MD.**  
Chairman BAC for Infrastructure,  
Medical Supplies and Services

## ***Section II. Instructions to Bidders***

### **Notes on the Instructions to Bidders**

This Section on the Instruction to Bidders (ITB) provides the information necessary for bidders to prepare responsive bids, in accordance with the requirements of the Procuring Entity. It also provides information on bid submission, eligibility check, opening and evaluation of bids, post-qualification, and on the award of contract.

## **1. Scope of Bid**

The Procuring Entity, *Philippine Heart Center* invites Bids for the *1 Lot Supply, Delivery and Installation of Fibe Optic Network (Re-Bid)*, with Project Identification Number *ITB No. 003.21*

The Procurement Project (referred to herein as “Project”) is for the construction of Works, as described in Section VI (Specifications).

## **2. Funding Information**

2.1. The GOP through the source of funding as indicated below for *[indicate funding year]* in the amount of *[indicate amount]*.

2.2. The source of funding is:

- a. GOCC and GFIs, the proposed Corporate Operating Budget.

## **3. Bidding Requirements**

The Bidding for the Project shall be governed by all the provisions of RA No. 9184 and its 2016 revised IRR, including its Generic Procurement Manual and associated policies, rules and regulations as the primary source thereof, while the herein clauses shall serve as the secondary source thereof.

Any amendments made to the IRR and other GPPB issuances shall be applicable only to the ongoing posting, advertisement, or invitation to bid by the BAC through the issuance of a supplemental or bid bulletin.

The Bidder, by the act of submitting its Bid, shall be deemed to have inspected the site, determined the general characteristics of the contracted Works and the conditions for this Project, such as the location and the nature of the work; (b) climatic conditions; (c) transportation facilities; (c) nature and condition of the terrain, geological conditions at the site communication facilities, requirements, location and availability of construction aggregates and other materials, labor, water, electric power and access roads; and (d) other factors that may affect the cost, duration and execution or implementation of the contract, project, or work and examine all instructions, forms, terms, and project requirements in the Bidding Documents.

## **4. Corrupt, Fraudulent, Collusive, Coercive, and Obstructive Practices**

The Procuring Entity, as well as the Bidders and Contractors, shall observe the highest standard of ethics during the procurement and execution of the contract. They or through an agent shall not engage in corrupt, fraudulent, collusive, coercive, and obstructive practices defined under Annex “I” of the 2016 revised IRR of RA No. 9184 or other integrity violations in competing for the Project.

## **5. Eligible Bidders**

- 5.1. Only Bids of Bidders found to be legally, technically, and financially capable will be evaluated.

- 5.2. The Bidder must have an experience of having completed a Single Largest Completed Contract (SLCC) that is similar to this Project, equivalent to at least fifty percent (50%) of the ABC adjusted, if necessary, by the Bidder to current prices using the PSA's CPI, except under conditions provided for in Section 23.4.2.4 of the 2016 revised IRR of RA No. 9184.

A contract is considered to be "similar" to the contract to be bid if it has the major categories of work stated in the **BDS**.

- 5.3. For Foreign-funded Procurement, the Procuring Entity and the foreign government/foreign or international financing institution may agree on another track record requirement, as specified in the Bidding Document prepared for this purpose.
- 5.4. The Bidders shall comply with the eligibility criteria under Section 23.4.2 of the 2016 IRR of RA No. 9184.

## **6. Origin of Associated Goods**

There is no restriction on the origin of Goods other than those prohibited by a decision of the UN Security Council taken under Chapter VII of the Charter of the UN.

## **7. Subcontracts**

- 7.1. The Bidder may subcontract portions of the Project to the extent allowed by the Procuring Entity as stated herein, but in no case more than fifty percent (50%) of the Project.

The Procuring Entity has prescribed that:

- a. Subcontracting is not allowed.

## **8. Pre-Bid Conference**

The Procuring Entity will hold a pre-bid conference for this Project on the specified date and time and either at its physical address *{[insert if applicable]}* and/or through videoconferencing/webcasting} as indicated in paragraph 6 of the **IB**.

## **9. Clarification and Amendment of Bidding Documents**

Prospective bidders may request for clarification on and/or interpretation of any part of the Bidding Documents. Such requests must be in writing and received by the Procuring Entity, either at its given address or through electronic mail indicated in the **IB**, at least ten (10) calendar days before the deadline set for the submission and receipt of Bids.

## **10. Documents Comprising the Bid: Eligibility and Technical Components**

- 10.1. The first envelope shall contain the eligibility and technical documents of the Bid as specified in **Section IX. Checklist of Technical and Financial Documents**.

- 10.2. If the eligibility requirements or statements, the bids, and all other documents for submission to the BAC are in foreign language other than English, it must be accompanied by a translation in English, which shall be authenticated by the appropriate Philippine foreign service establishment, post, or the equivalent office having jurisdiction over the foreign bidder's affairs in the Philippines. For Contracting Parties to the Apostille Convention, only the translated documents shall be authenticated through an apostille pursuant to GPPB Resolution No. 13-2019 dated 23 May 2019. The English translation shall govern, for purposes of interpretation of the bid.
- 10.3. A valid PCAB License is required, and in case of joint ventures, a valid special PCAB License, and registration for the type and cost of the contract for this Project. Any additional type of Contractor license or permit shall be indicated in the **BDS**.
- 10.4. A List of Contractor's key personnel (e.g., Project Manager, Project Engineers, Materials Engineers, and Foremen) assigned to the contract to be bid, with their complete qualification and experience data shall be provided. These key personnel must meet the required minimum years of experience set in the **BDS**.
- 10.5. A List of Contractor's major equipment units, which are owned, leased, and/or under purchase agreements, supported by proof of ownership, certification of availability of equipment from the equipment lessor/vendor for the duration of the project, as the case may be, must meet the minimum requirements for the contract set in the **BDS**.

## **11. Documents Comprising the Bid: Financial Component**

- 11.1. The second bid envelope shall contain the financial documents for the Bid as specified in **Section IX. Checklist of Technical and Financial Documents**.
- 11.2. Any bid exceeding the ABC indicated in paragraph 1 of the **IB** shall not be accepted.
- 11.3. For Foreign-funded procurement, a ceiling may be applied to bid prices provided the conditions are met under Section 31.2 of the 2016 revised IRR of RA No. 9184.

## **12. Alternative Bids**

Bidders shall submit offers that comply with the requirements of the Bidding Documents, including the basic technical design as indicated in the drawings and specifications. Unless there is a value engineering clause in the **BDS**, alternative Bids shall not be accepted.

## **13. Bid Prices**

All bid prices for the given scope of work in the Project as awarded shall be considered as fixed prices, and therefore not subject to price escalation during contract implementation, except under extraordinary circumstances as determined by the NEDA and approved by the GPPB pursuant to the revised Guidelines for Contract Price Escalation guidelines.

## **14. Bid and Payment Currencies**

- 14.1. Bid prices may be quoted in the local currency or tradeable currency accepted by the BSP at the discretion of the Bidder. However, for purposes of bid evaluation, Bids denominated in

foreign currencies shall be converted to Philippine currency based on the exchange rate as published in the BSP reference rate bulletin on the day of the bid opening.

14.2. *Payment of the contract price shall be made in:*

a. Philippine Pesos.

## **15. Bid Security**

15.1. The Bidder shall submit a Bid Securing Declaration or any form of Bid Security in the amount indicated in the **BDS**, which shall be not less than the percentage of the ABC in accordance with the schedule in the **BDS**.

15.2. The Bid and bid security shall be valid until *[indicate date]*. Any bid not accompanied by an acceptable bid security shall be rejected by the Procuring Entity as non-responsive.

## **16. Sealing and Marking of Bids**

Each Bidder shall submit one copy of the first and second components of its Bid.

The Procuring Entity may request additional hard copies (**copy 1 and copy 2**) and/or electronic copies of the Bid. However, failure of the Bidders to comply with the said request shall not be a ground for disqualification.

ENVELOPE 1 shall contain the following Orange folder in three separate envelopes properly marked as:

ORANGE FOLDER (1) – Original copies of Eligibility and Technical Documents as described in ITB Clause 20 (This should be enclosed in an envelope marked “*ORIGINAL ELIGIBILITY and TECHNICAL COMPONENT*”)

ORANGE FOLDER (2) - Original copies of Eligibility and Technical Documents as described in ITB Clause 20 (This should be enclosed in an envelope marked “*COPY NO.1 – ELIGIBILITY and TECHNICAL COMPONENT*”)

ORANGE FOLDER (3) - Original copies of Eligibility and Technical Documents as described in ITB Clause 20 (This should be enclosed in an envelope marked “*COPY NO.2 – ELIGIBILITY and TECHNICAL COMPONENT*”)

ENVELOPE 2 shall contain the following Yellow folder in three separate envelopes properly marked as:

YELLOW FOLDER (1) – Original copies of the Financial Documents as described in ITB Clause 20 (This should be enclosed in an envelope marked “*ORIGINAL FINANCIAL COMPONENT*”)

YELLOW FOLDER (2) - Original copies of the Financial Documents as described in ITB Clause 20 (This should be enclosed in an envelope marked “*COPY NO. 1 FINANCIAL COMPONENT*”)

YELLOW FOLDER (3) - Original copies of the Financial Documents as described in ITB Clause 20 (This should be enclosed in an envelope marked “*COPY NO.2 FINANCIAL COMPONENT*”)

If the Procuring Entity allows the submission of bids through online submission to the given website or any other electronic means, the Bidder shall submit an electronic copy of its Bid, which must be digitally signed. An electronic copy that cannot be opened or is corrupted shall be considered non-responsive and, thus, automatically disqualified.

## **17. Deadline for Submission of Bids**

The Bidders shall submit on the specified date and time and either at its physical address or through online submission as indicated in paragraph 7 of the **IB**.

## **18. Opening and Preliminary Examination of Bids**

- 18.1. The BAC shall open the Bids in public at the time, on the date, and at the place specified in paragraph 9 of the **IB**. The Bidders' representatives who are present shall sign a register evidencing their attendance. In case videoconferencing, webcasting or other similar technologies will be used, attendance of participants shall likewise be recorded by the BAC Secretariat.

In case the Bids cannot be opened as scheduled due to justifiable reasons, the rescheduling requirements under Section 29 of the 2016 revised IRR of RA No. 9184 shall prevail.

- 18.2. The preliminary examination of Bids shall be governed by Section 30 of the 2016 revised IRR of RA No. 9184.

## **19. Detailed Evaluation and Comparison of Bids**

- 19.1. The Procuring Entity's BAC shall immediately conduct a detailed evaluation of all Bids rated "*passed*" using non-discretionary pass/fail criteria. The BAC shall consider the conditions in the evaluation of Bids under Section 32.2 of 2016 revised IRR of RA No. 9184.
- 19.2. If the Project allows partial bids, all Bids and combinations of Bids as indicated in the **BDS** shall be received by the same deadline and opened and evaluated simultaneously so as to determine the Bid or combination of Bids offering the lowest calculated cost to the Procuring Entity. Bid Security as required by **ITB** Clause 16 shall be submitted for each contract (lot) separately.
- 19.3. In all cases, the NFCC computation pursuant to Section 23.4.2.6 of the 2016 revised IRR of RA No. 9184 must be sufficient for the total of the ABCs for all the lots participated in by the prospective Bidder.

## **20. Post Qualification**

Within a non-extendible period of five (5) calendar days from receipt by the Bidder of the notice from the BAC that it submitted the Lowest Calculated Bid, the Bidder shall submit its latest income and business tax returns filed and paid through the BIR Electronic Filing and Payment System (eFPS), and other appropriate licenses and permits required by law and stated in the **BDS**.



## **21. Signing of the Contract**

The documents required in Section 37.2 of the 2016 revised IRR of RA No. 9184 shall form part of the Contract. Additional Contract documents are indicated in the **BDS**.

## ***Section III. Bid Data Sheet***

### **Notes on the Bid Data Sheet (BDS)**

The Bid Data Sheet (BDS) consists of provisions that supplement, amend, or specify in detail, information, or requirements included in the ITB found in Section II, which are specific to each procurement.

This Section is intended to assist the Procuring Entity in providing the specific information in relation to corresponding clauses in the ITB and has to be prepared for each specific procurement.

The Procuring Entity should specify in the BDS information and requirements specific to the circumstances of the Procuring Entity, the processing of the procurement, and the bid evaluation criteria that will apply to the Bids. In preparing the BDS, the following aspects should be checked:

- 18.a. Information that specifies and complements provisions of the ITB must be incorporated.
- 18.b. Amendments and/or supplements, if any, to provisions of the ITB as necessitated by the circumstances of the specific procurement, must also be incorporated.

# Bid Data Sheet

| ITB Clause           |  |                            |                           |                            |  |  |  |
|----------------------|--|----------------------------|---------------------------|----------------------------|--|--|--|
| 5.2                  | For this purpose, contracts similar to the Project refer to contracts which have the same major categories of work, which shall be:<br><b><u>Any other IT related Projects</u></b>   |                            |                           |                            |  |  |  |
| 7.1                  | <i>[Specify the portions of Works and the maximum percentage allowed to be subcontracted, which shall not be significant or material components of the Project as determined by the Procuring Entity.]</i>   |                            |                           |                            |  |  |  |
| 10.3                 | <i>[Specify if another Contractor license or permit is required. ]</i>   |                            |                           |                            |  |  |  |
| 10.4                 | The key personnel must meet the required minimum years of experience set below:<br><br><table style="width: 100%; border-collapse: collapse;"> <thead> <tr> <th style="text-align: left; border-bottom: 1px solid black;"><u>Key Personnel</u></th> <th style="text-align: left; border-bottom: 1px solid black;"><u>General Experience</u></th> <th style="text-align: left; border-bottom: 1px solid black;"><u>Relevant Experience</u></th> </tr> </thead> <tbody> <tr> <td style="height: 20px;"></td> <td></td> <td></td> </tr> </tbody> </table> | <u>Key Personnel</u>       | <u>General Experience</u> | <u>Relevant Experience</u> |  |  |  |
| <u>Key Personnel</u> | <u>General Experience</u>  | <u>Relevant Experience</u> |                           |                            |  |  |  |
|                      |  |                            |                           |                            |  |  |  |
| 10.5                 | The minimum major equipment requirements are the following:<br><br><table style="width: 100%; border-collapse: collapse;"> <thead> <tr> <th style="text-align: left; border-bottom: 1px solid black;"><u>Equipment</u></th> <th style="text-align: left; border-bottom: 1px solid black;"><u>Capacity</u></th> <th style="text-align: left; border-bottom: 1px solid black;"><u>Number of Units</u></th> </tr> </thead> <tbody> <tr> <td style="height: 20px;"></td> <td></td> <td></td> </tr> </tbody> </table>                                       | <u>Equipment</u>           | <u>Capacity</u>           | <u>Number of Units</u>     |  |  |  |
| <u>Equipment</u>     | <u>Capacity</u>  | <u>Number of Units</u>     |                           |                            |  |  |  |
|                      |  |                            |                           |                            |  |  |  |
| 12                   | <i>[Insert Value Engineering clause if allowed.]</i>   |                            |                           |                            |  |  |  |
| 15.1                 | The bid security shall be in the form of a Bid Securing Declaration or any of the following forms and amounts:<br><ul style="list-style-type: none"> <li>a. The amount of not less than <b><u>P80,000.00</u></b>, if bid security is in cash, cashier's/manager's check, bank draft/guarantee or irrevocable letter of credit;</li> <li>b. The amount of not less than <b><u>P200,000.00</u></b> if bid security is in Surety Bond.</li> </ul>   |                            |                           |                            |  |  |  |
| 19.2                 | Partial bids are allowed, as follows:<br><i>[Insert grouping of lots by specifying the items and the quantity for every identified lot.]</i>   |                            |                           |                            |  |  |  |
| 20                   | <i>[List licenses and permits relevant to the Project and the corresponding law requiring it, e.g. Environmental Compliance Certificate, Certification that the project site is not within a geohazard zone, etc.]</i>   |                            |                           |                            |  |  |  |
| 21                   | Additional contract documents relevant to the Project that may be required by existing laws and/or the Procuring Entity, such as construction schedule and S-curve, manpower schedule, construction methods, equipment utilization schedule, construction safety and health program approved by the DOLE, and other acceptable tools of project scheduling.  |                            |                           |                            |  |  |  |

## ***Section IV. General Conditions of Contract***

### **Notes on the General Conditions of Contract**

The General Conditions of Contract (GCC) in this Section, read in conjunction with the Special Conditions of Contract in Section V and other documents listed therein, should be a complete document expressing all the rights and obligations of the parties.

Matters governing performance of the Contractor, payments under the contract, or matters affecting the risks, rights, and obligations of the parties under the contract are included in the GCC and Special Conditions of Contract.

Any complementary information, which may be needed, shall be introduced only through the Special Conditions of Contract.

## 1. **Scope of Contract**

This Contract shall include all such items, although not specifically mentioned, that can be reasonably inferred as being required for its completion as if such items were expressly mentioned herein. All the provisions of RA No. 9184 and its 2016 revised IRR, including the Generic Procurement Manual, and associated issuances, constitute the primary source for the terms and conditions of the Contract, and thus, applicable in contract implementation. Herein clauses shall serve as the secondary source for the terms and conditions of the Contract.

This is without prejudice to Sections 74.1 and 74.2 of the 2016 revised IRR of RA No. 9184 allowing the GPPB to amend the IRR, which shall be applied to all procurement activities, the advertisement, posting, or invitation of which were issued after the effectivity of the said amendment.

## 2. **Sectional Completion of Works**

If sectional completion is specified in the **Special Conditions of Contract (SCC)**, references in the Conditions of Contract to the Works, the Completion Date, and the Intended Completion Date shall apply to any Section of the Works (other than references to the Completion Date and Intended Completion Date for the whole of the Works).

## 3. **Possession of Site**

4.1. The Procuring Entity shall give possession of all or parts of the Site to the Contractor based on the schedule of delivery indicated in the **SCC**, which corresponds to the execution of the Works. If the Contractor suffers delay or incurs cost from failure on the part of the Procuring Entity to give possession in accordance with the terms of this clause, the Procuring Entity's Representative shall give the Contractor a Contract Time Extension and certify such sum as fair to cover the cost incurred, which sum shall be paid by Procuring Entity.

4.2. If possession of a portion is not given by the above date, the Procuring Entity will be deemed to have delayed the start of the relevant activities. The resulting adjustments in contract time to address such delay may be addressed through contract extension provided under Annex "E" of the 2016 revised IRR of RA No. 9184.

## 4. **The Contractor's Obligations**

The Contractor shall employ the key personnel named in the Schedule of Key Personnel indicating their designation, in accordance with **ITB** Clause 10.3 and specified in the **BDS**, to carry out the supervision of the Works.

The Procuring Entity will approve any proposed replacement of key personnel only if their relevant qualifications and abilities are equal to or better than those of the personnel listed in the Schedule.

## 5. **Performance Security**

- 5.1. Within ten (10) calendar days from receipt of the Notice of Award from the Procuring Entity but in no case later than the signing of the contract by both parties, the successful Bidder shall furnish the performance security in any of the forms prescribed in Section 39 of the 2016 revised IRR.
- 5.2. The Contractor, by entering into the Contract with the Procuring Entity, acknowledges the right of the Procuring Entity to institute action pursuant to RA No. 3688 against any subcontractor be they an individual, firm, partnership, corporation, or association supplying the Contractor with labor, materials and/or equipment for the performance of this Contract.

## **6. Site Investigation Reports**

The Contractor, in preparing the Bid, shall rely on any Site Investigation Reports referred to in the SCC supplemented by any information obtained by the Contractor.

## **7. Warranty**

- 7.1. In case the Contractor fails to undertake the repair works under Section 62.2.2 of the 2016 revised IRR, the Procuring Entity shall forfeit its performance security, subject its property(ies) to attachment or garnishment proceedings, and perpetually disqualify it from participating in any public bidding. All payables of the GOP in his favor shall be offset to recover the costs.
- 7.2. The warranty against Structural Defects/Failures, except that occasioned-on force majeure, shall cover the period from the date of issuance of the Certificate of Final Acceptance by the Procuring Entity. Specific duration of the warranty is found in the SCC.

## **8. Liability of the Contractor**

Subject to additional provisions, if any, set forth in the SCC, the Contractor's liability under this Contract shall be as provided by the laws of the Republic of the Philippines.

If the Contractor is a joint venture, all partners to the joint venture shall be jointly and severally liable to the Procuring Entity.

## **9. Termination for Other Causes**

Contract termination shall be initiated in case it is determined *prima facie* by the Procuring Entity that the Contractor has engaged, before, or during the implementation of the contract, in unlawful deeds and behaviors relative to contract acquisition and implementation, such as, but not limited to corrupt, fraudulent, collusive, coercive, and obstructive practices as stated in ITB Clause 4.

## **10. Dayworks**

Subject to the guidelines on Variation Order in Annex "E" of the 2016 revised IRR of RA No. 9184, and if applicable as indicated in the SCC, the Dayworks rates in the Contractor's Bid shall be used for small additional amounts of work only when the

Procuring Entity's Representative has given written instructions in advance for additional work to be paid for in that way.

## **11. Program of Work**

11.1. The Contractor shall submit to the Procuring Entity's Representative for approval the said Program of Work showing the general methods, arrangements, order, and timing for all the activities in the Works. The submissions of the Program of Work are indicated in the SCC.

11.2. The Contractor shall submit to the Procuring Entity's Representative for approval an updated Program of Work at intervals no longer than the period stated in the SCC. If the Contractor does not submit an updated Program of Work within this period, the Procuring Entity's Representative may withhold the amount stated in the SCC from the next payment certificate and continue to withhold this amount until the next payment after the date on which the overdue Program of Work has been submitted.

## **12. Instructions, Inspections and Audits**

The Contractor shall permit the GOP or the Procuring Entity to inspect the Contractor's accounts and records relating to the performance of the Contractor and to have them audited by auditors of the GOP or the Procuring Entity, as may be required.

## **13. Advance Payment**

The Procuring Entity shall, upon a written request of the Contractor which shall be submitted as a Contract document, make an advance payment to the Contractor in an amount not exceeding fifteen percent (15%) of the total contract price, to be made in lump sum, or at the most two installments according to a schedule specified in the SCC, subject to the requirements in Annex "E" of the 2016 revised IRR of RA No. 9184.

## **14. Progress Payments**

The Contractor may submit a request for payment for Work accomplished. Such requests for payment shall be verified and certified by the Procuring Entity's Representative/Project Engineer. Except as otherwise stipulated in the SCC, materials and equipment delivered on the site but not completely put in place shall not be included for payment.

## **15. Operating and Maintenance Manuals**

15.1. If required, the Contractor will provide "as built" Drawings and/or operating and maintenance manuals as specified in the SCC.

15.2. If the Contractor does not provide the Drawings and/or manuals by the dates stated above, or they do not receive the Procuring Entity's Representative's approval, the Procuring Entity's Representative may withhold the amount stated in the SCC from payments due to the Contractor.

## ***Section V. Special Conditions of Contract***

### **Notes on the Special Conditions of Contract**

Similar to the BDS, the clauses in this Section are intended to assist the Procuring Entity in providing contract-specific information in relation to corresponding clauses in the GCC found in Section IV.

The Special Conditions of Contract (SCC) complement the GCC, specifying contractual requirements linked to the special circumstances of the Procuring Entity, the Procuring Entity's country, the sector, and the Works procured. In preparing this Section, the following aspects should be checked:

- a. Information that complements provisions of the GCC must be incorporated.
- b. Amendments and/or supplements to provisions of the GCC as necessitated by the circumstances of the specific purchase, must also be incorporated.

However, no special condition which defeats or negates the general intent and purpose of the provisions of the GCC should be incorporated herein.



# Special Conditions of Contract

| GCC Clause |   |
|------------|---|
| 2          | <i>[If different dates are specified for completion of the Works by section, i.e. "sectional completion," these dates should be listed here.]</i>   |
| 4.1        | <p><i>[Specify the schedule of delivery of the possession of the site to the Contractor, whether full or in part.]</i></p> <p>The <b>Intended Completion Date</b> is <b>Thirty (30)</b> calendar days upon receipt of the Notice to Proceed (NTP)</p> <p><b><i>NOTE : The contract duration shall be reckoned from the start date and not from contract effectivity date.</i></b></p>   |
| 6          | The site investigation reports are: <i>[list here the required site investigation reports.]</i>   |
| 7.2        | <p><i>[Select one, delete the other.]</i></p> <p><i>[In case of permanent structures, such as buildings of types 4 and 5 as classified under the National Building Code of the Philippines and other structures made of steel, iron, or concrete which comply with relevant structural codes (e.g., DPWH Standard Specifications), such as, but not limited to, steel/concrete bridges, flyovers, aircraft movement areas, ports, dams, tunnels, filtration and treatment plants, sewerage systems, power plants, transmission and communication towers, railway system, and other similar permanent structures:]</i> Fifteen (15) years.</p> <p><i>[In case of semi-permanent structures, such as buildings of types 1, 2, and 3 as classified under the National Building Code of the Philippines, concrete/asphalt roads, concrete river control, drainage, irrigation lined canals, river landing, deep wells, rock causeway, pedestrian overpass, and other similar semi-permanent structures:]</i> Five (5) years.</p> <p><i>[In case of other structures, such as bailey and wooden bridges, shallow wells, spring developments, and other similar structures:]</i> Two (2) years.</p> |
| 10         | <p><i>[Select one, delete the other:]</i></p> <p style="padding-left: 40px;">1.1.a.1.i.1.a. Dayworks are applicable at the rate shown in the Contractor's original Bid.</p> <p style="padding-left: 40px;">1.1.a.1.i.1.b. No dayworks are applicable to the contract.</p>   |
| 11.1       | The Contractor shall submit the Program of Work to the Procuring Entity's Representative within <i>[insert number]</i> days of delivery of the Notice of Award.   |
| 11.2       | The amount to be withheld for late submission of an updated Program of Work is <i>[insert amount]</i> .   |
| 13         | The amount of the advance payment is <i>[insert amount as percentage of the contract price that shall not exceed 15% of the total contract price and schedule of payment]</i> .   |
| 14         | <i>[If allowed by the Procuring Entity, state:]</i> Materials and equipment delivered on the site but not completely put in place shall be included for payment.  |

|      |   |
|------|---|
| 15.1 | The date by which operating and maintenance manuals are required is <i>[date]</i> .<br>The date by which “as built” drawings are required is <i>[date]</i> .              |
| 15.2 | The amount to be withheld for failing to produce “as built” drawings and/or operating and maintenance manuals by the date required is <i>[amount in local currency]</i> . |

## **A. Determination of Lowest Calculated Bidder**

## **B. Detailed Bid Evaluation (Eligibility and Technical Specification)**

### **C. Post-Qualification**

**The post-qualification shall verify, validate, and ascertain all statements made and documents submitted by the bidder with the Lowest Calculated Bid/Highest Rated Bid, using non-discretionary criteria, as stated in the Bidding Documents. These criteria shall consider, but shall not be limited to, the following:**

#### **Class “A” Documents**

##### **Legal Documents**

1. Valid PhilGEPS Registration Certificate (Platinum Membership) (all pages);.or
2. Registration certificate from Securities and Exchange Commission (SEC), Department of Trade and Industry (DTI) for sole proprietorship, or Cooperative Development Authority (CDA) for cooperatives or its equivalent document, and
3. Mayor’s or Business permit issued by the city or municipality where the principal place of business of the prospective bidder is located, or the equivalent document for Exclusive Economic Zones or Areas; and
4. Tax clearance per E.O. No. 398, s. 2005, as finally reviewed and approved by the Bureau of Internal Revenue (BIR).

##### **Technical Documents**

5. Statement of the prospective bidder of all its ongoing government and private contracts, including contracts awarded but not yet started, if any, whether similar or not similar in nature and complexity to the contract to be bid; **and**
6. Statement of the bidder’s Single Largest Completed Contract (SLCC) similar to the contract to be bid, except under conditions provided for in Sections 23.4.1.3 and 23.4.2.4 of the 2016 revised IRR of RA No. 9184, within the relevant period as provided in the Bidding Documents; **and**
7. Original copy of Bid Security. If in the form of a Surety Bond, submit also a certification issued by the Insurance Commission;  
**or**  
Original copy of Notarized Bid Securing Declaration; **and**

8. Conformity with the Technical Specifications, which may include production/delivery schedule, manpower requirements, and/or after-sales/parts, if applicable; **and**
9. Original duly signed Omnibus Sworn Statement (OSS);  
**and** if applicable, Original Notarized Secretary's Certificate in case of a corporation, partnership, or cooperative; or Original Special Power of Attorney of all members of the joint venture giving full power and authority to its officer to sign the OSS and do acts to represent the Bidder.

Financial Documents

10. The Supplier's audited financial statements, showing, among others, the Supplier's total and current assets and liabilities, stamped "received" by the BIR or its duly accredited and authorized institutions, for the preceding calendar year which should not be earlier than two (2) years from the date of bid submission;  
**and**
11. The prospective bidder's computation of Net Financial Contracting Capacity (NFCC);  
**or**  
A committed Line of Credit from a Universal or Commercial Bank in lieu of its NFCC computation.

**Class "B" Documents**

12. If applicable, a duly signed joint venture agreement (JVA) in case the joint venture is already in existence;  
**or**  
duly notarized statements from all the potential joint venture partners stating that they will enter into and abide by the provisions of the JVA in the instance that the bid is successful.

Other documentary requirements under RA No. 9184 (as applicable)

13. *[For foreign bidders claiming by reason of their country's extension of reciprocal rights to Filipinos]* Certification from the relevant government office of their country stating that Filipinos are allowed to participate in government procurement activities for the same item or product.
14. Certification from the DTI if the Bidder claims preference as a Domestic Bidder or Domestic Entity.
15. Latest Income Tax Return (for monthly or quarterly tax remittance) *(Only tax returns filed and taxes paid through the BIR EFPS shall be accepted)*

16. Latest Business Tax (Percentage tax or VAT) Returns (*Only tax returns filed and taxes paid through the BIR EFPS shall be accepted*)
17. For those who submitted a Notarized Statement to form a Joint Venture during the Opening of Bids, the Joint Venture Agreement will be submitted with a disclosure of the percentage of ownership of both parties.
18. All parties to the Joint Venture shall submit the following:
  - a) Latest Income Tax Returns (for monthly or quarterly tax remittance) (*Only tax returns filed and taxes paid through the BIR EFPS shall be accepted*)
  - b) Latest Business Tax (Percentage tax or VAT) Returns (*Only tax returns filed and taxes paid through the BIR EFPS shall be accepted*)
  - c) Certificate of PhilGEPS Registration (Platinum Membership)
19. Duly Notarized Certificate of Good Standing, Completion, **AND** Acceptance from PHC. Said Certification must be issued within the past twelve (12) months from bid submission. (This is applicable only to prospective bidder **with** previous contracts and completed projects with the PHC entered into within the past three (3) years from the submission and receipt of bids); **OR**  
  
Duly Notarized Certificate of Good Standing, Completion, **OR** Acceptance from at least one (1) previous client. Said Certification must be issued within the past twelve (12) months from bid submission. (This is applicable only to prospective bidders **without** previous contracts and completed projects with the PHC).
20. Product Demonstration (if required through a written notification by the BAC)

## *Section VI. Specifications*

### **Notes on Specifications**

A set of precise and clear specifications is a prerequisite for Bidders to respond realistically and competitively to the requirements of the Procuring Entity without qualifying or conditioning their Bids. In the context of international competitive bidding, the specifications must be drafted to permit the widest possible competition and, at the same time, present a clear statement of the required standards of workmanship, materials, and performance of the goods and services to be procured. Only if this is done will the objectives of economy, efficiency, and fairness in procurement be realized, responsiveness of Bids be ensured, and the subsequent task of bid evaluation facilitated. The specifications should require that all goods and materials to be incorporated in the Works be new, unused, of the most recent or current models, and incorporate all recent improvements in design and materials unless provided otherwise in the Contract.

Samples of specifications from previous similar projects are useful in this respect. The use of metric units is mandatory. Most specifications are normally written specially by the Procuring Entity or its representative to suit the Works at hand. There is no standard set of Specifications for universal application in all sectors in all regions, but there are established principles and practices, which are reflected in these PBDs.

There are considerable advantages in standardizing General Specifications for repetitive Works in recognized public sectors, such as highways, ports, railways, urban housing, irrigation, and water supply, in the same country or region where similar conditions prevail. The General Specifications should cover all classes of workmanship, materials, and equipment commonly involved in construction, although not necessarily to be used in a particular Works Contract. Deletions or addenda should then adapt the General Specifications to the particular Works.

Care must be taken in drafting specifications to ensure that they are not restrictive. In the specification of standards for goods, materials, and workmanship, recognized international standards should be used as much as possible. Where other particular standards are used, whether national standards or other standards, the specifications should state that goods, materials, and workmanship that meet other authoritative standards, and which ensure substantially equal or higher quality than the standards mentioned, will also be acceptable. The following clause may be inserted in the SCC.

#### **Sample Clause: Equivalency of Standards and Codes**

Wherever reference is made in the Contract to specific standards and codes to be met by the goods and materials to be furnished, and work performed or tested, the provisions of the latest current edition or revision of the relevant standards and codes in effect shall apply, unless otherwise expressly stated in the Contract. Where such standards and codes are national, or relate to a particular country or region, other authoritative standards that ensure a substantially equal or higher quality than the standards and codes specified will be accepted subject to the Procuring Entity's Representative's prior review and written consent. Differences between the standards specified and the proposed alternative

standards shall be fully described in writing by the Contractor and submitted to the Procuring Entity's Representative at least twenty-eight (28) days prior to the date when the Contractor desires the Procuring Entity's Representative's consent. In the event the Procuring Entity's Representative determines that such proposed deviations do not ensure substantially equal or higher quality, the Contractor shall comply with the standards specified in the documents.

These notes are intended only as information for the Procuring Entity or the person drafting the Bidding Documents. They should not be included in the final Bidding Documents.

## ***Section VII. Drawings***

*[Insert here a list of Drawings. The actual Drawings, including site plans, should be attached to this section, or annexed in a separate folder.]*

***“ANNEX A” - PHC Network (PHCNet) System***

***“ANNEX B” - Medical Arts Bldg.***

***“ANNEX C” - MAB Annex***

***“ANNEX D” - Hospital Bldg.***

***“ANNEX E” - New ER Bldg.***



## ***Section VIII. Bill of Quantities***

### **Notes on the Bill of Quantities**

#### **Objectives**

The objectives of the Bill of Quantities are:

- a.i.a. to provide sufficient information on the quantities of Works to be performed to enable Bids to be prepared efficiently and accurately; and
- a.i.b. when a Contract has been entered into, to provide a priced Bill of Quantities for use in the periodic valuation of Works executed.

In order to attain these objectives, Works should be itemized in the Bill of Quantities in sufficient detail to distinguish between the different classes of Works, or between Works of the same nature carried out in different locations or in other circumstances which may give rise to different considerations of cost. Consistent with these requirements, the layout and content of the Bill of Quantities should be as simple and brief as possible.

#### **Daywork Schedule**

A Daywork Schedule should be included only if the probability of unforeseen work, outside the items included in the Bill of Quantities, is high. To facilitate checking by the Entity of the realism of rates quoted by the Bidders, the Daywork Schedule should normally comprise the following:

- a. A list of the various classes of labor, materials, and Constructional Plant for which basic daywork rates or prices are to be inserted by the Bidder, together with a statement of the conditions under which the Contractor will be paid for work executed on a daywork basis.
- b. Nominal quantities for each item of Daywork, to be priced by each Bidder at Daywork rates as Bid. The rate to be entered by the Bidder against each basic Daywork item should include the Contractor's profit, overheads, supervision, and other charges.

#### **Provisional Sums**

A general provision for physical contingencies (quantity overruns) may be made by including a provisional sum in the Summary Bill of Quantities. Similarly, a contingency allowance for possible price increases should be provided as a provisional sum in the Summary Bill of Quantities. The inclusion of such provisional sums often facilitates budgetary approval by avoiding the need to request periodic supplementary approvals as the future need arises. Where such provisional sums or contingency allowances are used, the SCC should state the manner in which they will be used, and under whose authority (usually the Procuring Entity's Representative's).

The estimated cost of specialized work to be carried out, or of special goods to be supplied,

by other contractors should be indicated in the relevant part of the Bill of Quantities as a particular provisional sum with an appropriate brief description. A separate procurement procedure is normally carried out by the Procuring Entity to select such specialized contractors. To provide an element of competition among the Bidders in respect of any facilities, amenities, attendance, etc., to be provided by the successful Bidder as prime Contractor for the use and convenience of the specialist contractors, each related provisional sum should be followed by an item in the Bill of Quantities inviting the Bidder to quote a sum for such amenities, facilities, attendance, etc.

### **Signature Box**

A signature box shall be added at the bottom of each page of the Bill of Quantities where the authorized representative of the Bidder shall affix his signature. Failure of the authorized representative to sign each and every page of the Bill of Quantities shall be a cause for rejection of his bid.

These Notes for Preparing a Bill of Quantities are intended only as information for the Procuring Entity or the person drafting the Bidding Documents. They should not be included in the final documents.

*“ANNEX F” - Scope of Works (Probable Project Cost)*

## ***Section IX. Checklist of Technical and Financial Documents***

### **Notes on the Checklist of Technical and Financial Documents**

The prescribed documents in the checklist are mandatory to be submitted in the Bid, but shall be subject to the following:

- a. GPPB Resolution No. 09-2020 on the efficient procurement measures during a State of Calamity or other similar issuances that shall allow the use of alternate documents in lieu of the mandated requirements; or
- b. any subsequent GPPB issuances adjusting the documentary requirements after the effectivity of the adoption of the PBDs.

The BAC shall be checking the submitted documents of each Bidder against this checklist to ascertain if they are all present, using a non-discretionary “pass/fail” criterion pursuant to Section 30 of the 2016 revised IRR of RA No. 9184.

# Checklist of Technical and Financial Documents

## I. TECHNICAL COMPONENT ENVELOPE

### *Class “A” Documents*

#### Legal Documents

- (1.1.a) Valid PhilGEPS Registration Certificate (Platinum Membership) (all pages);  
**or**
- (1.1.b) Registration certificate from Securities and Exchange Commission (SEC), Department of Trade and Industry (DTI) for sole proprietorship, or Cooperative Development Authority (CDA) for cooperatives or its equivalent document;  
**and**
- (1.1.c) Mayor’s or Business permit issued by the city or municipality where the principal place of business of the prospective bidder is located, or the equivalent document for Exclusive Economic Zones or Areas;  
**and**
- (e) Tax clearance per E.O. No. 398, s. 2005, as finally reviewed and approved by the Bureau of Internal Revenue (BIR).

#### Technical Documents

- (f) Statement of the prospective bidder of all its ongoing government and private contracts, including contracts awarded but not yet started, if any, whether similar or not similar in nature and complexity to the contract to be bid; **and**
- (g) Statement of the bidder’s Single Largest Completed Contract (SLCC) similar to the contract to be bid, except under conditions provided under the rules; **and**
- (h) Philippine Contractors Accreditation Board (PCAB) License;  
**or**  
Special PCAB License in case of Joint Ventures;  
**and** registration for the type and cost of the contract to be bid; **and**
- (i) Original copy of Bid Security. If in the form of a Surety Bond, submit also a certification issued by the Insurance Commission;  
**or**  
Original copy of Notarized Bid Securing Declaration; **and**
- (j) Project Requirements, which shall include the following:
  - a. Organizational chart for the contract to be bid;
  - b. List of contractor’s key personnel (e.g., Project Manager, Project Engineers, Materials Engineers, and Foremen), to be assigned to the contract to be bid, with their complete qualification and experience data;
  - c. List of contractor’s major equipment units, which are owned, leased, and/or under purchase agreements, supported by proof of ownership or certification of availability of equipment from the equipment lessor/vendor for the duration of the project, as the case may be; **and**
- (k) Original duly signed Omnibus Sworn Statement (OSS);  
**and** if applicable, Original Notarized Secretary’s Certificate in case

of a corporation, partnership, or cooperative; or Original Special Power of Attorney of all members of the joint venture giving full power and authority to its officer to sign the OSS and do acts to represent the Bidder.

Financial Documents

- (l) The prospective bidder's audited financial statements, showing, among others, the prospective bidder's total and current assets and liabilities, stamped "received" by the BIR or its duly accredited and authorized institutions, for the preceding calendar year which should not be earlier than two (2) years from the date of bid submission; **and**
- (m) The prospective bidder's computation of Net Financial Contracting Capacity (NFCC).

***Class "B" Documents***

- (n) If applicable, duly signed joint venture agreement (JVA) in accordance with RA No. 4566 and its IRR in case the joint venture is already in existence;  
**or**  
duly notarized statements from all the potential joint venture partners stating that they will enter into and abide by the provisions of the JVA in the instance that the bid is successful.

**Or Certificate of Simplified Supplier's Registration (CSSR)**

**II. FINANCIAL COMPONENT ENVELOPE**

- (o) Original of duly signed and accomplished Financial Bid Form; **and**

Other documentary requirements under RA No. 9184

- (p) Original of duly signed Bid Prices in the Bill of Quantities; **and**
- (q) Duly accomplished Detailed Estimates Form, including a summary sheet indicating the unit prices of construction materials, labor rates, and equipment rentals used in coming up with the Bid; **and**
- (r) Cash Flow by Quarter.

## Omnibus Sworn Statement (Revised)

*[shall be submitted with the Bid]*

---

REPUBLIC OF THE PHILIPPINES )  
CITY/MUNICIPALITY OF \_\_\_\_\_ ) S.S.

### AFFIDAVIT

I, [Name of Affiant], of legal age, [Civil Status], [Nationality], and residing at [Address of Affiant], after having been duly sworn in accordance with law, do hereby depose and state that:

*c. [Select one, delete the other:]*

*[If a sole proprietorship:]* I am the sole proprietor or authorized representative of [Name of Bidder] with office address at [address of Bidder];

*[If a partnership, corporation, cooperative, or joint venture:]* I am the duly authorized and designated representative of [Name of Bidder] with office address at [address of Bidder];

*25 [Select one, delete the other:]*

*[If a sole proprietorship:]* As the owner and sole proprietor, or authorized representative of [Name of Bidder], I have full power and authority to do, execute and perform any and all acts necessary to participate, submit the bid, and to sign and execute the ensuing contract for [Name of the Project] of the [Name of the Procuring Entity], as shown in the attached duly notarized Special Power of Attorney;

*[If a partnership, corporation, cooperative, or joint venture:]* I am granted full power and authority to do, execute and perform any and all acts necessary to participate, submit the bid, and to sign and execute the ensuing contract for [Name of the Project] of the [Name of the Procuring Entity], as shown in the attached [state title of attached document showing proof of authorization (e.g., duly notarized Secretary's Certificate, Board/Partnership Resolution, or Special Power of Attorney, whichever is applicable)];

14. [Name of Bidder] is not "blacklisted" or barred from bidding by the Government of the Philippines or any of its agencies, offices, corporations, or Local Government Units, foreign government/foreign or international financing institution whose blacklisting rules have been recognized by the Government Procurement Policy Board, **by itself or by relation, membership, association, affiliation, or controlling interest with another blacklisted person or entity as defined and provided for in the Uniform Guidelines on Blacklisting;**

b. Each of the documents submitted in satisfaction of the bidding requirements is an authentic copy of the original, complete, and all statements and information provided therein are true and correct;

c. [Name of Bidder] is authorizing the Head of the Procuring Entity or its duly authorized representative(s) to verify all the documents submitted;

1 [Select one, delete the rest:]

[If a sole proprietorship:] The owner or sole proprietor is not related to the Head of the Procuring Entity, members of the Bids and Awards Committee (BAC), the Technical Working Group, and the BAC Secretariat, the head of the Project Management Office or the end-user unit, and the project consultants by consanguinity or affinity up to the third civil degree;

[If a partnership or cooperative:] None of the officers and members of [Name of Bidder] is related to the Head of the Procuring Entity, members of the Bids and Awards Committee (BAC), the Technical Working Group, and the BAC Secretariat, the head of the Project Management Office or the end-user unit, and the project consultants by consanguinity or affinity up to the third civil degree;

[If a corporation or joint venture:] None of the officers, directors, and controlling stockholders of [Name of Bidder] is related to the Head of the Procuring Entity, members of the Bids and Awards Committee (BAC), the Technical Working Group, and the BAC Secretariat, the head of the Project Management Office or the end-user unit, and the project consultants by consanguinity or affinity up to the third civil degree;

(b) [Name of Bidder] complies with existing labor laws and standards; and

10.6. [Name of Bidder] is aware of and has undertaken the responsibilities as a Bidder in compliance with the Philippine Bidding Documents, which includes:

- a. Carefully examining all of the Bidding Documents;
- b. Acknowledging all conditions, local or otherwise, affecting the implementation of the Contract;
- c. Making an estimate of the facilities available and needed for the contract to be bid, if any; and
- d. Inquiring or securing Supplemental/Bid Bulletin(s) issued for the [Name of the Project].

III. [Name of Bidder] did not give or pay directly or indirectly, any commission, amount, fee, or any form of consideration, pecuniary or otherwise, to any person or official, personnel or representative of the government in relation to any procurement project or activity.

**IV. In case advance payment was made or given, failure to perform or deliver any of the obligations and undertakings in the contract shall be sufficient grounds to constitute criminal liability for Swindling (Estafa) or the commission of fraud with unfaithfulness or abuse of confidence through misappropriating or converting any payment received by a person or entity under an obligation involving the duty to deliver certain goods or services, to the prejudice of the public and the government of the Philippines pursuant to Article 315 of Act No. 3815 s. 1930, as amended, or the Revised Penal Code.**

IN WITNESS WHEREOF, I have hereunto set my hand this \_\_ day of \_\_, 20\_\_ at \_\_\_\_\_, Philippines.

*[Insert NAME OF BIDDER OR ITS AUTHORIZED  
REPRESENTATIVE]*

*[Insert signatory's legal capacity]*

Affiant

**[Jurat]**

*[Format shall be based on the latest Rules on Notarial Practice]*



## **Bid Securing Declaration Form**

*[shall be submitted with the Bid if bidder opts to provide this form of bid security]*

---

REPUBLIC OF THE PHILIPPINES)  
CITY OF \_\_\_\_\_ ) S.S.

### **BID SECURING DECLARATION** **Project Identification No.: *[Insert number]***

To: *[Insert name and address of the Procuring Entity]*

I/We, the undersigned, declare that:

b. I/We understand that, according to your conditions, bids must be supported by a Bid Security, which may be in the form of a Bid Securing Declaration.

c. I/We accept that: (a) I/we will be automatically disqualified from bidding for any procurement contract with any procuring entity for a period of two (2) years upon receipt of your Blacklisting Order; and, (b) I/we will pay the applicable fine provided under Section 6 of the Guidelines on the Use of Bid Securing Declaration, within fifteen (15) days from receipt of the written demand by the procuring entity for the commission of acts resulting to the enforcement of the bid securing declaration under Sections 23.1(b), 34.2, 40.1 and 69.1, except 69.1(f), of the IRR of RA No. 9184; without prejudice to other legal action the government may undertake.

d. I/We understand that this Bid Securing Declaration shall cease to be valid on the following circumstances:

a.i.1. Upon expiration of the bid validity period, or any extension thereof pursuant to your request;

a.i.2. I am/we are declared ineligible or post-disqualified upon receipt of your notice to such effect, and (i) I/we failed to timely file a request for reconsideration or (ii) I/we filed a waiver to avail of said right; and

a.i.3. I am/we are declared the bidder with the Lowest Calculated Responsive Bid, and I/we have furnished the performance security and signed the Contract.

IN WITNESS WHEREOF, I/We have hereunto set my/our hand/s this \_\_\_\_ day of *[month]* *[year]* at *[place of execution]*.  
\_\_\_\_\_

*[Insert NAME OF BIDDER OR ITS AUTHORIZED REPRESENTATIVE]*

*[Insert signatory's legal capacity]*

Affiant

***[Jurat]***

*[Format shall be based on the latest Rules on Notarial Practice]*

# Bid Form for the Procurement of Infrastructure Projects

*[shall be submitted with the Bid]*

---

## BID FORM

Date : \_\_\_\_\_

Project Identification No. : \_\_\_\_\_

To: *[name and address of Procuring Entity]*

Having examined the Philippine Bidding Documents (PBDs) including the Supplemental or Bid Bulletin Numbers *[insert numbers]*, the receipt of which is hereby duly acknowledged, we, the undersigned, declare that:

2 We have no reservation to the PBDs, including the Supplemental or Bid Bulletins, for the Procurement Project: *[insert name of contract]*;

3 We offer to execute the Works for this Contract in accordance with the PBDs;

4 The total price of our Bid in words and figures, excluding any discounts offered below is: *[insert information]*;

5 The discounts offered and the methodology for their application are: *[insert information]*;

6 The total bid price includes the cost of all taxes, such as, but not limited to: *[specify the applicable taxes, e.g. (i) value added tax (VAT), (ii) income tax, (iii) local taxes, and (iv) other fiscal levies and duties]*, which are itemized herein and reflected in the detailed estimates,

7 Our Bid shall be valid within the a period stated in the PBDs, and it shall remain binding upon us at any time before the expiration of that period;

8 If our Bid is accepted, we commit to obtain a Performance Security in the amount of *[insert percentage amount]* percent of the Contract Price for the due performance of the Contract, or a Performance Securing Declaration in lieu of the the allowable forms of Performance Security, subject to the terms and conditions of issued GPPB guidelines<sup>2</sup> for this purpose;

9 We are not participating, as Bidders, in more than one Bid in this bidding process, other than alternative offers in accordance with the Bidding Documents;

10 We understand that this Bid, together with your written acceptance thereof

---

<sup>2</sup>currently based on GPPB Resolution No. 09-2020

included in your notification of award, shall constitute a binding contract between us, until a formal Contract is prepared and executed; and

11 We understand that you are not bound to accept the Lowest Calculated Bid or any other Bid that you may receive.

12 We likewise certify/confirm that the undersigned, is the duly authorized representative of the bidder, and granted full power and authority to do, execute and perform any and all acts necessary to participate, submit the bid, and to sign and execute the ensuing contract for the [Name of Project] of the [Name of the Procuring Entity].

13 We acknowledge that failure to sign each and every page of this Bid Form, including the Bill of Quantities, shall be a ground for the rejection of our bid.

Name: \_\_\_\_\_

Legal Capacity: \_\_\_\_\_

Signature: \_\_\_\_\_

Duly authorized to sign the Bid for and behalf of: \_\_\_\_\_

*Date:* \_\_\_\_\_



# **SUPPLY, DELIVERY AND INSTALLATION OF FIBER OPTIC CABLE NETWORK SYSTEM**

## **1. Background of the Project**

### 1.1. Overview

The project aims to enhance the interconnection of the units/offices of the Philippine Heart Center (PHC) by enabling faster communication, easier access to shared services, integrate functions, and simplify processes. The fiber optic backbone will be able to reap the benefits of lower costs of internet services and faster data transfers for effective government-to-government/government-to-public transactions.

### 1.2. Brief Description

The Project includes the supply, delivery, and installation Fiber Optic Cable (FOC) Network System in the PHC.

## **2. Purpose of the Procurement**

### 2.1. Rationale

The purpose of the Project is to upgrade the existing structured copper cabling in the PHC and integrate fiber optic cabling to the PHC Network (PHCNet) System. This will deliver faster communication and ease of access of the citizenry to government services, and most of all, enhance the PHC's mission-critical network architecture to be highly flexible, scalable, and ensuring the convergence of all services (data, voice, and video) on to a single Passive Optical LAN (POL).

By future-proofing the PHCNet System, it will be ready to support all types of new healthcare technologies and applications that may be developed to achieve higher quality at lower costs. The capacity of the new infrastructure will be sufficient in the coming years, and future requirement for higher bandwidth will be easier and more cost-efficient.

## **3. Scope of Work**

### 3.1. Supply, Delivery, Installation and Acceptance

The Work includes the supply of engineering services, furnishing of materials, labor, supervision, supplies, and performance of all operations necessary to complete the Project, all in accordance with the Contract documents and subject to the terms and conditions of the Contract.

The Work covers the design-and-build of the above-mentioned Project particularly the following components:

- 3.1.1. Survey and preparation of engineering design/plan prior to installation;
- 3.1.2. As-built of all plans and drawings (detailed map, cable route, termination, splicing, etc.) required by the Project;
- 3.1.3. Structural cabling installation (cable trays, conduits/tubings, and accessories);
- 3.1.4. Laying of fiber optic cable (Refer to Annexes "A", "B", "C", "D", and "E");
- 3.1.5. Installation of Optical Distribution Frames (ODF)/Patch Panels, Network Access Cabinets, Fiber Optic Patch Cords/Pig Tails, Optical Fiber Trays, and other accessories inside the PHC Data Center and MDF/IDF Rooms;
- 3.1.6. Splicing and termination of Fiber Optic Cable (FOC);

3.1.7. Testing and commissioning (provisional and final acceptance) of newly-installed FOC (in accordance with TIA-526-7 OFSTP-7 Measurement of Optical Power Loss of Installed Single-Mode Fiber Cable Plant);

3.1.8. Configuration of Network Active Components (10G uplink connection) and other equipment installed in the PHC Data Center and MDF/IDF Rooms;

3.1.9. Grooming of existing copper cabling in the PHC Data Center and MDF/IDF Rooms; and

3.2.0. Restoration of all affected facilities.

Note: Scope of work for the Fiber Optic Cable (FOC) Network will be up to the Optical Distribution Frame (ODF) only.

All connections are to be directly terminated to the ODFs/Patch Panels.

## 3.2. Deliverables

### 3.2.1. Survey, Engineering and Construction/Design

3.2.1.1. The Contractor is required to carry out the detailed site survey and engineering for Fiber Optic Cable Routes to justify the installation and construction designs.

3.2.1.2. The Contractor shall submit a detailed work plan and installation design drawings to the PHC for approval within ten (10) calendar days after receipt of Contract and prior to installation. The Management Information Systems Division (MISD) and Engineering and Maintenance Division (EMD) of the PHC will check and review the design drawings accompanied by justification/verification reports, and will give their decision whether the design drawings are acceptable or not, within one (1) week from the date of the PHC receipt of design drawings.

3.2.1.3. As part of each telecommunications work order/project, detail schematic drawings shall be prepared for each fiber optic span/cable route, showing the following information:

#### 3.2.1.3.1. Fiber cable data:

3.2.1.3.1.1. Cable manufacturer;

3.2.1.3.1.2. Cable size (number of fibers);

3.2.1.3.1.3. Cable type;

3.2.1.3.1.4. Cable make-up;

3.2.1.3.1.5. Type of fiber;

3.2.1.3.1.6. Transmission characteristics (dB loss/km at given wavelength); and

3.2.1.3.1.7. Dispersion specification in ps/(nm . km).

#### 3.2.1.3.2. Other information:

3.2.1.3.2.1. Trunk number/cable number;

3.2.1.3.2.2. Span length;

3.2.1.3.2.3. Manhole/handhole number and duct number;

3.2.1.3.2.4. Fiber cable splice points with station location;

3.2.1.3.2.5. Splice-to-splice cable lengths;

3.2.1.3.2.6. Change in cable route; and

#### 3.2.1.3.2.7. Budget loss link calculation.

#### 3.2.1.4. Preparation of Design Drawings

3.2.1.4.1. The Contractor shall, at his own expense, produce installation/construction designs/drawings in conformity with design principles, and are to be approved by the PHC.

3.2.1.4.2. The Contractor shall produce the installation/construction designs/drawing on standard size paper.

3.2.1.4.3. The Contractor shall supply drawings in a Computer-aided Design (CAD) format.

3.2.1.4.4. Route plan including the splicing point, termination point, and ODF.

#### 3.2.1.5. Kinds of Construction Plan/Design

All Construction Plans/Designs shall be in accordance with the PHC Specifications. Construction Plans/Designs are composed of:

##### 3.2.1.5.1. Key Map for Optical Fiber Cable route

Key map is to indicate the proposed optical fiber cable route between two nodes with latest route conditions as well as future plan along the route.

##### 3.2.1.5.2. Optical fiber cable arrangement and termination on ODF frames.

This drawing shall cover terminations in the MDF/IDF Rooms; location of ODF, assignment and arrangement of termination, and detailed cable runs.

##### 3.2.1.5.3. Schematic diagram for fiber optics cores splicing assignment

This drawing shall cover all necessary factors for interfacing with transmission systems as the line system design.

##### 3.2.1.5.4. Cable Entrance Facilities/Structural Cabling inside the PHC

Note:

For all the construction/engineering design in hard copy, the following must be included:

1. The proposed Contractor's Fiber Network in Infra Map/Diagram as basis for implementation, duly signed by a licensed Professional Electronics and Communication Engineer (PECE).
2. Link Loss Budget Calculation from nodes to nodes: (Note: Link loss budget calculation from nodes to nodes should not be more than 6db at 1310nm).

Formula in computing the budget loss calculation:

*cable loss + splice losses + connector losses = Budget loss calculation*

Wherein:

*cable loss = db/km x km splice loss = db/splice x number of splice*

3.2.1.6. The Contractor must conduct due diligence and shall restudy and amend/modify the design drawings not only dependent upon the comments of the PHC but also taking into consideration the design concept, and shall resubmit the modified design drawings to the PHC within one (1) week after receipt of the PHC comments for their approval.

3.2.1.7. In case the Contractor's re-study of the design is incomplete, and the PHC disapproval is repeated, then the Contractor shall be fully responsible for any delay in progress, cost of re-design etc., and the PHC will keep the right to order the replacement of the Contractor's engineer/management in charge of installation/construction design at the Contractor's own expense.

### 3.2.2. Bill of Quantities

3.2.2.1. Refer to Annex "F"

3.2.2.2. For actual measurement of lengths of Fiber Optic Cable and quantity of EMT Tubings, the PHC will allow access to scaled blue-print plans of structural layout available at the Engineering and Maintenance Division (EMD) after coordinating with the Management Information Systems Division (MISD).

### 3.2.3. Reports, Specifications, Practices and Procedures

3.2.3.1. The following Reports, Specifications, Practices and Procedures shall be prepared by the Contractor, called as the "Technical Documents" in this paragraph, to be approved by the PHC. The Contractor must submit a progress report every Monday.

3.2.3.1.1. Survey report

3.2.3.1.2. Design reports

3.2.3.1.3. Material Specifications for Fiber Optic Cable

3.2.3.1.4. Installation/Construction Practices for Fiber Optic Cable

3.2.3.1.5. Test procedures

3.2.3.1.6. Inspection and Acceptance Test Procedures, for Optical Fiber Cable Systems.

3.2.3.1.7. Others

3.2.3.2. The Contractor shall submit to the PHC the specified numbers of original and of copies of all the technical documents such as:

3.2.3.2.1. Softcopy, in original editable format, of all as-built plans and drawings involved in the project;

3.2.3.2.2. Design standard and application details;

3.2.3.2.3. Survey and design reports;

3.2.3.2.4. Material Specifications;

3.2.3.2.5. Installation/Construction Practices in accordance with ITU-T Standard;

3.2.3.2.6. Test Procedures; and

3.2.3.2.7. Inspection and Acceptance Test Procedures.

3.2.3.2.8. Others

### 3.2.4. As-Built Drawings

The following as-built drawing having the same sizes as the designs/drawings:

3.2.4.1. General Map to cover all of the serving area;

3.2.4.2. Key Map for Cable Route (each cable section);



- 3.2.4.3. Detailed fiber core assignments (each cable section/splicing point);
- 3.2.4.5. Junction Cable Location Map (each cable section);
- 3.2.4.6. Optical Fiber Cable Arrangement and Termination on the fiber distribution frame;
- 3.2.4.7. Schematic diagram for Fiber Optics Cores Assignment;
- 3.2.4.8. Structured Cabling Plan/Cable route plan from insertion/splicing point to inside PHC equipment/IDF room.
- 3.2.4.9. Special Design Drawing, if any.

### 3.2.5. Fiber Optic Cable Specifications

#### 3.2.5.1. General Scope

This covers the minimum requirement of single mode optical fiber cables for the FOC Network as per ITU-T Recommendation G.652D standard.

All the terms used in this specification of single-mode optical fiber cable shall be as defined in the latest ITU-T Recommendation G.652d.

Characteristics not clearly defined in these specifications shall comply with the latest ITU-T G.652D recommendation.

#### 3.2.5.2. Cable Construction: General considerations

The basic purpose is to keep transmission and mechanical strength properties stable in the course of the cable manufacturing process, cable installation work, and operation.

The optical fiber cables and accessories offered must be mechanically strong and chemically resistant to be suitable for use under extreme hot and humid conditions.

#### 3.2.5.3. Design Consideration

The maximum number of optical fibers in a loose tube shall be 12 fibers for cables 48-fiber and above. This requirement must be strictly complied.

The loose tubes and interstices of cable core shall be filled with a suitable compound that could prevent long term penetration of water. Information on the material used for the filling compound shall be stated by the manufacturer.

##### 3.2.5.3.1. Figure-8/Self-support Fiber optic cable

Figure 8 cable has a cable bonded to an insulated steel or all dielectric messenger for support.

###### 3.2.5.3.1.1. Cable Sheath

###### 3.2.5.3.1.2. Strength Member

3.2.5.3.1.2.1. One or more strength members shall be incorporated into a cable structure designed to carry the tensile load associated with installation.

3.2.5.3.1.2.2. The fiber reinforced plastic (FRP), serving mainly as the central strength member must be laminated with an MDPE-Jacket to prevent disintegration/breakage of plastic materials used.

##### 3.2.5.3.2. Packing of Cables

Cable protection shall include, as a minimum, a covering placed between the cable reel flanges and over the exposed layer of the cable. The covering shall be weather resistant and shall limit solar heating of the cable such that the cable surface temperature does not exceed 10°C above ambient temperatures under maximum solar radiation.

The cable ends shall be accessible for testing, and securely fastened to the reel to prevent the cable from becoming loose in transit or during cable installation.

End caps shall be securely installed to each cable end to prevent escape of filling compound and entry of moisture during shipping, handling, and storage.

The manufacturer shall state the sizes of cable drums used for the purpose of packing the offered single mode optical fiber cables. The minimum diameter of spool of the cable drums shall be at least 20 times the cable diameter.

The spindle hole of each cable drum shall be greater than 100mm.

Cable length per reel/drum must be continuous.

#### 3.2.5.3.3. Cable Sizes

The manufacturer shall state the outer diameter of the various sizes of the single mode fiber optic cables offered, subject to the PHC's approval.

#### 3.2.6. Supply of Wireless Access Points

3.2.6.1. The Wireless Access Points should be compatible, manageable, and configurable with the existing Firewall appliance of the PHC.

3.2.6.2. The installation of the Wireless Access Points will be borne by the PHC.

#### 3.2.7. Pre-installation

3.2.7.1. The Contractor is required to designate a qualified on-site engineer for proper supervision and coordination of the project. He must undergo interview with the PHC FOC Team for verification.

3.2.7.2. The Contractor shall keep the design accurate and practical.

3.2.7.3. The PHC will provide a fifteen (15) square meter enclosed space for storage area.

Contractor is required to maintain the quantity of materials in their storage area. A Stock Custodian must always update and maintain record of the list of components and materials, and prepare reports when stocks are being used.

In case of any loss or damage on the materials provided by the PHC, the Contractor will be accountable and must immediately replace the said materials.

#### 3.2.7.4. Personnel Protective Equipment (PPE) and Safety Devices

Contractor must also provide and ensure that all personnel are wearing proper PPE at all times and use safety device in their working area to avoid any accident.

#### 3.2.7.5. Handling and Storage Procedures

Contractor shall ensure that all FOC, equipment and materials necessary for the Project are properly handled and secured.

Contractor must submit Handling and Storage Procedures particularly of the Fiber Optic Cable. This also includes the shipment or transfer of FOC when necessary.

### 3.3. Duration of the Contract

Upon issuance of Notice to Proceed, the duration of the contract is one hundred twenty (120) calendar days for installation of the FOC Network and related works.

### 3.4. Warranty

3.4.1. The Contractor warrants that Goods supplied under the Contract are new, unused, of the most recent or current models, and that they incorporate all recent improvements in design, materials, except when the technical specifications required by the PHC provides otherwise;

3.4.2. The Contractor further warrants that all Goods supplied under the Contract shall have no defect, arising from design, materials, workmanship, or from any act of omission of the Contractor that may develop under the normal use of the Supplied Goods;

3.4.3. The Warranty shall cover full replacement of defective items, free of charge, including labor, spare parts and materials.

3.4.3.1. In order to assure that manufacturing defects shall be corrected by the Contractor, a Warranty shall be required from the Contractor for a minimum period of three (3) years. The obligation for the Warranty shall be covered by, at the Contractor's option, either retention money in an amount equivalent to at least one percent (1%) of every progress payment, or a special bank guarantee equivalent to at least one percent (1%) of the Total Contract Price. The said amounts shall only be released after the lapse of the Warranty period; provided, however, that the supplies delivered are free from patent and latent defects and all the conditions imposed under the Contract have been fully met.

3.4.3.2. The PHC shall promptly notify the Contractor in writing of any claim arising under this Warranty. Upon receipt of such notice, the Contractor shall, within ten (10) days, and with all reasonable speed, repair or replace the defective Goods or parts thereof, without cost to the PHC.

3.4.3.3. If the Contractor, having been notified, fails to remedy the defect(s) within ten (10) days, the PHC may proceed to take such remedial action as may be necessary, at the Contractor's risk and expense and without prejudice to any other rights which the PHC may have against the Contractor under the Contract and under the applicable law.

### 3.5. Implementation or Work Schedule

3.5.1. The Contractor shall submit an integrated project implementation plan showing the following:

3.5.1.1. Detailed work plan, including milestones and critical tasks, in implementing the project within the allotted one hundred twenty (120) calendar days from date of receipt of Notice to Proceed (NTP);

3.5.1.2. Number of work teams at any given time;

3.5.1.3. Specific dates for work and quality inspection by the PHC team.

3.5.2. The Contractor shall submit integrated implementation updates every 1st day of the week (Monday) to the PHC throughout the contractual installation/construction period from the effective date of the Contract until the completion of the Project showing the following detailed milestone, and in accordance with the established schedule and priorities.

3.5.3. The implementation shall be accurate and include the following considerations:

3.5.3.1. To ensure that the work-force is well-distributed through the contractual period taking quality control and timely progress into consideration;

3.5.3.2. To allow sufficient time and manpower for self-inspections/tests prior to being witnessed by the PHC for interim inspections/tests and provisional acceptance tests;

3.5.3.3. To allow reasonable time for witnessing by the PHC of interim inspections/tests considering the work sequence such as cable laying work after the PHC has accepted completed systems;

3.5.3.4. To ensure the sites are properly managed so as to ensure adequacy of site security arrangements.

3.5.3.5. To keep sufficient time and manpower from transferring site know-how quality control, tools/formats, standard safety arrangement, first aid, etc., to the local staff and local foreman.

3.5.3.6. To make sure the quality/functions of domestic products fully conform to the specifications any time necessary to upgrade the same.

3.5.4. The Contractor shall be responsible for conforming to the integrated implementation schedules as strictly as possible after examination and approval by the PHC.

3.5.5. If discrepancies/ambiguities are found or some deviation is necessary in the actual implementation progress, the Contractor shall report the same to the PHC and shall take all corrective actions/measures at Contractor's own expense in accordance with the instructions given by the PHC.

3.5.6. The initial synchronized and integrated implementation schedule specified for the project shall be submitted for the PHC approval within five (5) days after the effective date of the Contract.

#### **4. Evaluation Process**

Contractors must submit the following as part of the Technical Documents during bid submission:

4.1. Written Statement of the Contractor signed by their authorized representative that they have at least five (5) years of direct experience on planning, engineering, supply and delivery, installation, testing and commissioning and experience in operations and maintenance of optical fiber transmission backbone projects/systems in the Philippines.

4.2. Contractor shall submit resumé of key personnel to be assigned to the Project. These key personnel are the:

- PECE;
- Project Manager; and
- Project On-site Engineer

4.3. Must hold a PCAB License on Communications Facilities for a minimum of five (5) consecutive years from the date of Bid Opening. (In case of renewal, must submit official receipt on the filing of the application for renewal of PCAB License)

#### **5. Testing and Acceptance**

The Contractor is responsible in the performance of all civil and cable network pre-test requirement but not limited to:

5.1. Fiber Optic Cable (FOC) – attenuation and all its related testing, power meter test, and grounding test and all other test that may need to perform to complete the FOC test requirements.

5.1.1. End-to-end acceptance tests (typically conducted after completion of installation and splicing and before installing terminal equipment).

5.1.3. End-to-end attenuation is the amount of optical power loss between cable system connector tips. This will include the fiber and splice/connector loss in the cable system after it has been installed.

5.1.4. Splice acceptance tests (individual splice insertion losses)

5.1.4.1. splice loss shall not be above 0.1 dB for fusion splices; and

5.1.4.2. connectors shall have insertion losses of 0.5 dB or less.

Note: All test equipment that will be utilized for this Project shall have updated calibration certificates to ensure accuracy of results. Contractor is required to submit Calibration Certificates prior to testing.

## 5.2. Link Loss Requirements

During the design stage, a link loss calculation shall be prepared and included with the project proposal and design packages. The link loss budget shall include:

5.2.1. Total fiber attenuation (loss), not more than 6db.

5.2.2. Splice loss (including pigtail splices, if pigtails are used).

5.2.3. Connector loss.

5.2.4. The calculated dB loss cannot exceed the operating range of the terminal equipment that will be installed. Measured end-to-end loss should measure less than the calculated loss. Fibers that measure a higher loss than the link loss budget will not be accepted.

## 5.3. Contractor Performance and Workmanship

5.3.1. The PHC will issue provisional and final acceptance certificate to the Contractor certifying that the scope of work has been performed and accomplished in accordance with the approved plans and specification schedules, variation orders, if any, and other related contract documents.

5.3.2. The Contractor likewise agrees to correct any defect accruing after the final acceptance of the site facility under the project within the guarantee period. Effective duration of which shall be one (1) year commencing from the date of final acceptance by the PHC.

## 6. Progress Payment

6.1. Once a month, the Contractor may submit a Statement of Work Accomplished (SWA) or progress billing and corresponding request for Progress Payment for work accomplished. The SWA should show the amounts which the Contractor considers itself to be entitled to up to the end of the month, to cover:

6.1.1. Cumulative value of the works it executed to date, based on the items in the Bill of Quantities; and

6.1.2. Adjustments made for approved variation orders executed.

6.2. The PHC shall check the Contractor's monthly SWA and certify the amount to be paid to the Contractor as Progress Payment. Except as otherwise stipulated in the Instructions given by the PHC, materials and equipment delivered on the site but not completely put in place shall not be included for payment.

6.3. The PHC shall deduct the following from the certified gross amounts to be paid to the Contractor as Progress Payment:

6.3.1. Cumulative value of the work previously certified and paid for.

6.3.2. Portion of the advance payment to be recouped for the month.

6.3.3. Retention money in accordance with the condition of Contract.

6.3.4. Amount to cover third party liabilities.

6.3.5. Amount to cover uncorrected discovered defects in the works.

## **7. Timelines for Implementation of the Project**

### **7.1. Conduct of Site Survey**

Within five (5) calendar days after receipt of Notice to Proceed

### **7.2. Submission of Engineering Design**

Within five (5) calendar days after site survey

### **7.3. Construction, installation, splicing and termination of Fiber Optic Cables (FOC)**

Within seventy-five (75) calendar days after delivery of Engineering Design

### **7.4. Pre-test, pre-acceptance, and commissioning of laid-out Fiber Optic Cable Network**

Within five (5) calendar days after completion of the construction and installation of the FOC Network

### **7.5. Configuration of Network Active Components and other equipment**

Within five (5) calendar days after completion of commissioning of the FOC Network

### **7.6. Final Testing and Acceptance of FOC Network**

Within five (5) calendar days after configuration of network active components

### **7.7. Grooming of copper cables and restoration of affected facilities**

Within twenty (20) calendar days after final testing and acceptance of FOC Network

Hospital Bldg.

Medical Arts Bldg.

Annex "A"

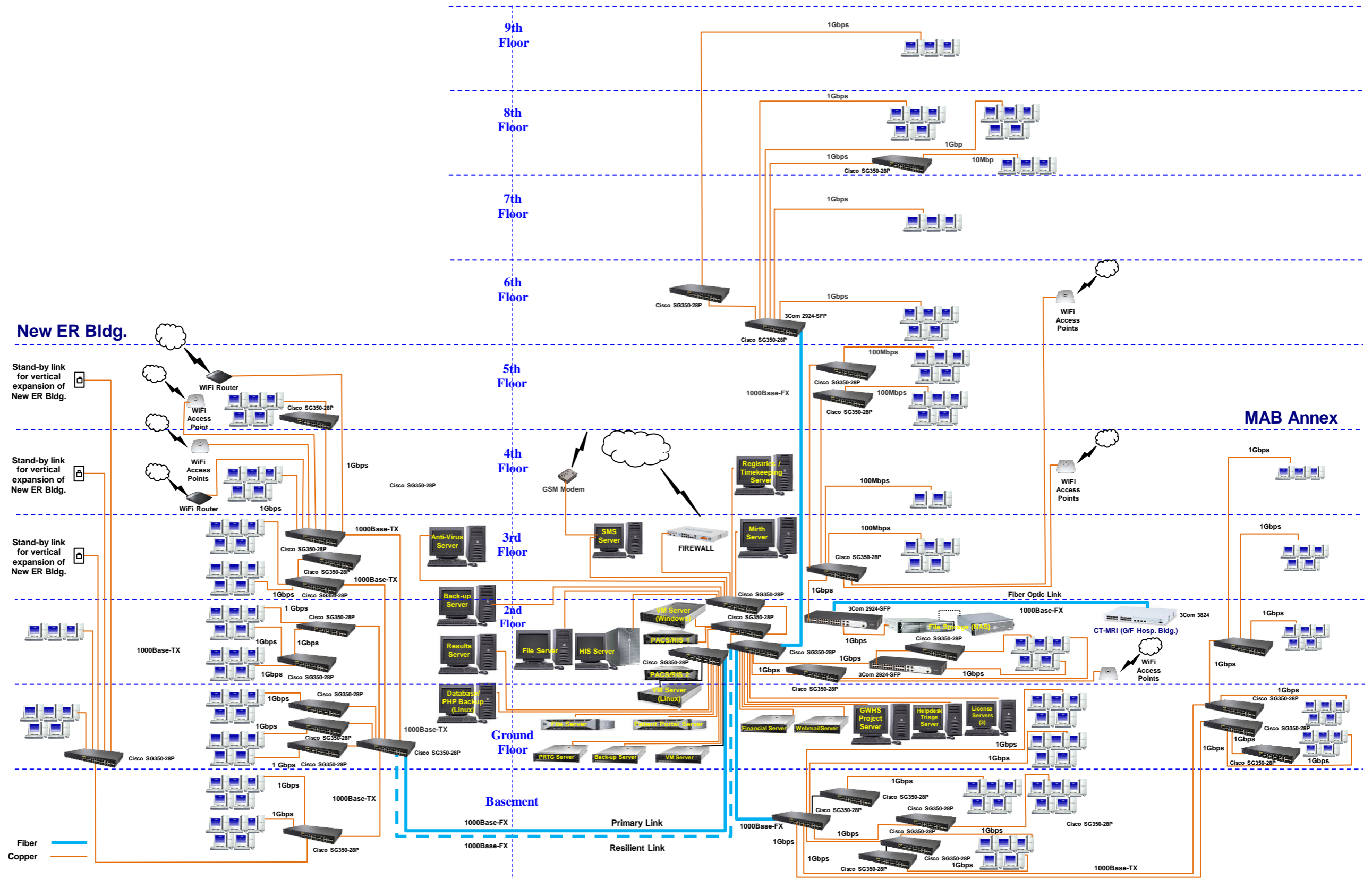

**PHC Network (PHCNet) System**

# Medical Arts Bldg.

# Annex "B"

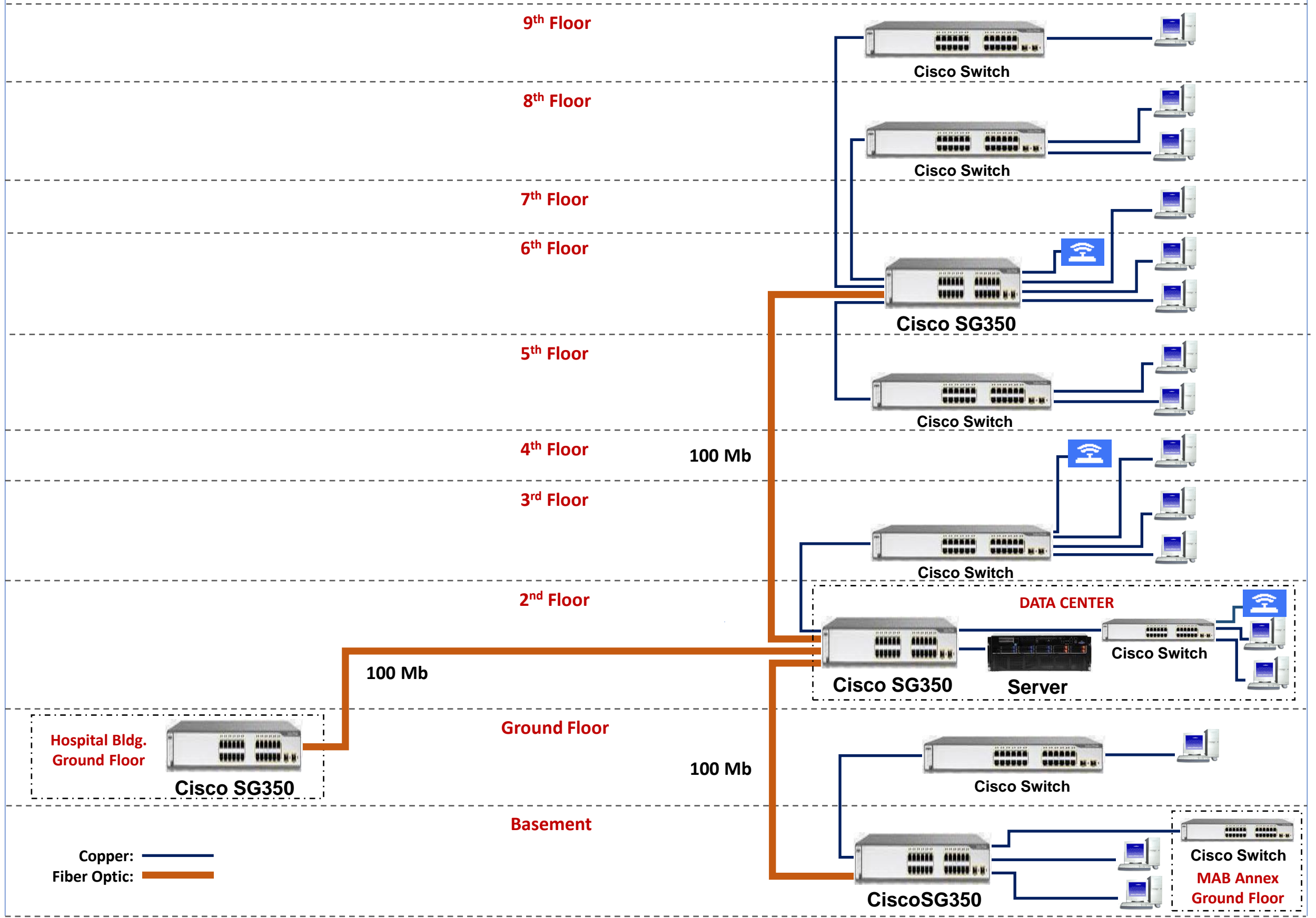

9th Floor

8th Floor

7th Floor

6th Floor

5th Floor

4th Floor

3rd Floor

2nd Floor

Ground Floor

Basement

Cisco Switch

Cisco Switch

Cisco SG350

Cisco Switch

Cisco Switch

Cisco SG350

Server

Cisco Switch

Cisco Switch

CiscoSG350

Cisco Switch

MAB Annex  
Ground Floor

DATA CENTER

100 Mb

100 Mb

100 Mb

Hospital Bldg.  
Ground Floor

Cisco SG350

Copper:   
Fiber Optic: 



4<sup>th</sup> Floor

3<sup>rd</sup> Floor

2<sup>nd</sup> Floor

Ground Floor

Basement

Medical Arts Bldg.  
Basement

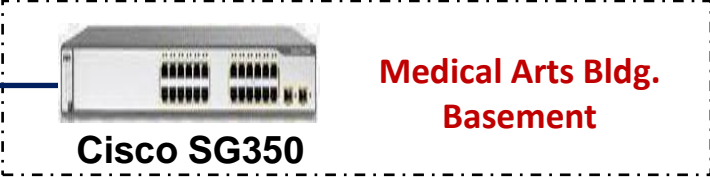
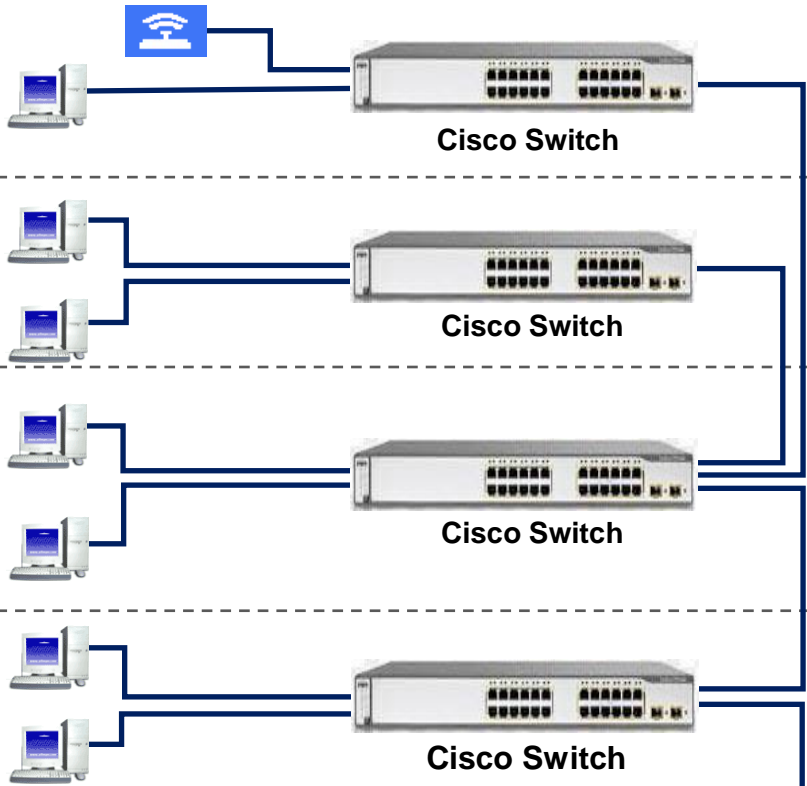

Copper: ———  
Fiber Optic: ———

**Hospital Bldg.**

**Annex "D"**

5<sup>th</sup> Floor

4<sup>th</sup> Floor

3<sup>rd</sup> Floor

2<sup>nd</sup> Floor

Ground Floor

Basement

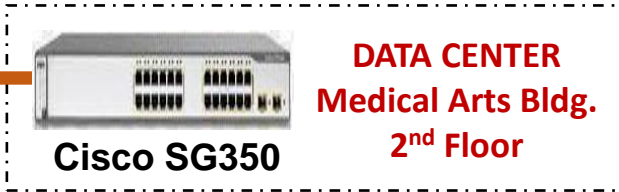
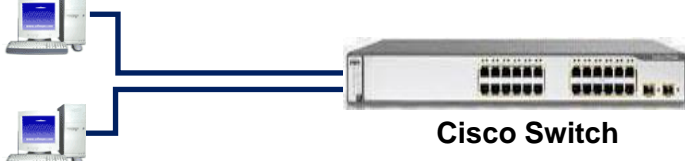
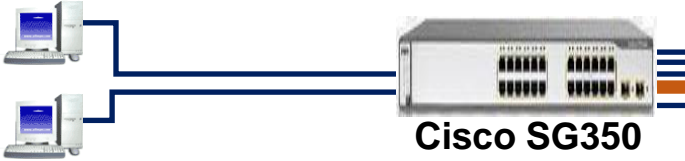
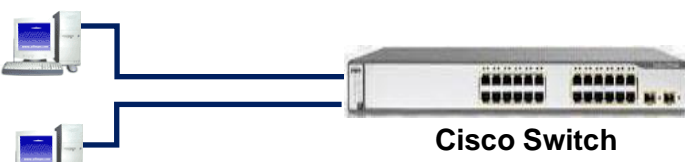
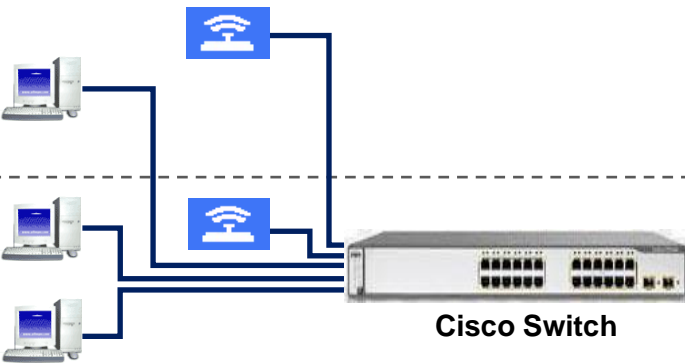

100 Mb

Copper: 

Fiber Optic: 

New ER Bldg.

Annex "E"

5<sup>th</sup> Floor



Cisco SG350



4<sup>th</sup> Floor



Cisco SG350



3<sup>rd</sup> Floor



Cisco SG350



2<sup>nd</sup> Floor



Cisco SG350



Ground Floor



Cisco SG30



Basement

Hospital Bldg.  
Basement

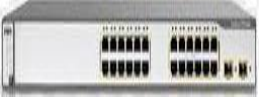

Cisco SG350

Copper:   
Fiber Optic: 

